



## Copyright Notice & Disclaimers

**Copyright © 2001-2009 PortaOne, Inc. All rights reserved.**

**PortaUM Administrator Guide  
V.1.19.4, May 2009**

Please address your comments and suggestions to: Sales Department,  
PortaOne, Inc. Suite #408, 2963 Glen Drive, Coquitlam BC V3B 2P7  
Canada.

Changes may be made periodically to the information in this publication. Such changes will be incorporated in new editions of the guide. The software described in this document is furnished under a license agreement, and may be used or copied only in accordance with the terms thereof. It is against the law to copy the software on any other medium, except as specifically provided in the license agreement. The licensee may make one copy of the software for backup purposes. No part of this publication may be reproduced, stored in a retrieval system, or transmitted in any form or by any means, electronic, mechanical, photocopied, recorded or otherwise, without the prior written permission of PortaOne, Inc.

The software license and limited warranty for the accompanying products are set forth in the information packet supplied with the product, and are incorporated herein by this reference. If you cannot locate the software license, contact your PortaOne representative for a copy.

All product names mentioned in this manual are for identification purposes only, and are either trademarks or registered trademarks of their respective owners.

## Table of Contents

Preface .....	3
Hardware and Software Requirements .....	4
Installation .....	5
What's New in Maintenance Release 19? .....	5
<b>1. System Concepts .....</b>	<b>6</b>
PortaUM's Role in Your VoIP Network .....	7
PortaUM Components .....	8
PortaUM Performance .....	9
PortaUM Clustering .....	10
Conceptual Elements .....	12
Call Process .....	13
Auto Attendant .....	15
Call Queues .....	21
Dial-by-name Directory .....	22
Supported Services .....	23
<b>2. Setting Up and Using UM Services .....</b>	<b>27</b>
Setting Up UM Services .....	28
Setting Up and Using Prepaid IVR on PortaUM .....	43
<b>3. PortaBridge .....</b>	<b>50</b>
PortaBridge Architecture .....	51
<b>4. Setting Up and Using Conferencing Services .....</b>	<b>53</b>
Setting Up Conferencing Services in PortaBridge .....	54
<b>5. Administration .....</b>	<b>68</b>
PortaUM Configuration .....	69

## Preface

This document provides a general overview of PortaUM (Unified Messaging System), a platform for the delivery of enhanced business and residential communications services. PortaUM handles voice, fax, and regular email messages as objects in a single mailbox, which users can access via a web interface or by telephone.

## Where to Get the Latest Version of This Guide

The hard copy of this guide is updated at major releases only, and does not always contain the latest material on enhancements occurring between minor releases. The online copy of this guide is always up-to-date, and integrates the latest changes to the product. You can access the latest copy of this guide at [www.portaone.com/support/documentation/](http://www.portaone.com/support/documentation/)

## Conventions

This publication uses the following conventions:

- Commands and keywords are given in **boldface**
- Terminal sessions, console screens, or system file names are displayed in fixed width font



**Caution** indicates that the described action might result in program malfunction or data loss.

**NOTE:** Notes contain helpful suggestions about or references to materials not contained in this manual.



**Timesaver** means that you can save time by performing the action described in the paragraph.



**Tips** provide information that might help you solve a problem.

## Hardware and Software Requirements



PortaUM can use its own built-in media server, or it can make use of an external Cisco gateway as a media server. Should you decide to use a Cisco gateway for this purpose, please note that this requires a *dedicated* Cisco AS 5300/5350, i.e. you cannot run other applications on it (such as wholesale termination or calling cards). No Cisco gateway is required if you wish to run the IVR embedded into PortaUM.

### Cisco Requirements

128M RAM, 16M flash for AS5300 (32M for AS5350), E1 or T1 voice ports, sufficient number of DSPs, IOS 12.3.13 (or the latest available from the 12.3 branch).

AS5300 comes with 4 or 8 T1/E1s. You will not need more than 4 of them, due to the DSP resource limitation for AS5300.

For a T1 configuration, the maximum voice resource will be 96, and for E1 — 120.

### Client System Recommendations

- OS: Windows 95-XP, UNIX or Mac OS
- Java Virtual Machine Support (JRE 1.4.2\_01 or later)
- Browser: Internet Explorer 6.0 or higher, Netscape 7.1 / Mozilla 1.6 or higher, supporting DOM and with JavaScript enabled
- Spreadsheet processor (MS Excel)
- Display settings:
  - Min Screen Resolution: 1024 x 768
  - Color Palette: 16 bit color (minimum)

**NOTE:** To view downloaded CDR files in Windows, proceed as follows in order to match the PortaBilling default list separator: My Computer -> Control Panel -> Regional Settings -> Number -> List Separator type “,”.

## Installation

PortaUM is provided via a jump-start installation CD. This CD contains installation media for FreeBSD (6.3-stable branch, with the latest security bug fixes), supplementary packages necessary for convenient system administration and maintenance, and PortaUM software packages.

PortaUM installation and configuration are automated and integrated within the main installation process. This allows you to install a completely functional PortaUM server from scratch in less than 15 minutes! In order to complete the installation process, your Cisco UM gateway must be configured according to the configuration guidelines.

For detailed installation instructions, please refer to the [PortaUM Installation Guide](#).

## What's New in Maintenance Release 19?

This release includes several new features and improvements:

- Voice-to-text services – A new voicemail received by the user can be processed using the GotVoice service platform. The user will then receive a text message with the contents of the voicemail.
- Fax-only account - In addition to voicemail and auto attendant, it is now possible to answer an incoming call with a “start fax” tone. This emulates the behavior of legacy fax machines, thus simplifying businesses’ migration to the IP Centrex platform.

# 1 . System Concepts

## PortaUM's Role in Your VoIP Network

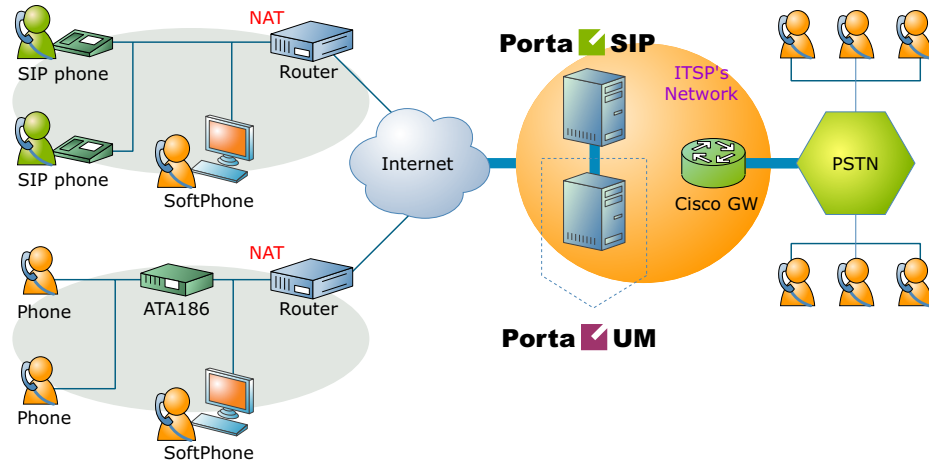

**PortaUM** (Unified Messaging system) is one of the key components of PortaSwitch, a software-based communication service and subscriber management platform that directly addresses the needs of modern communication network providers seeking new revenue streams from tools that unify voice, data and fax traffic within a single network, and which enable diversification of their current offer of services.

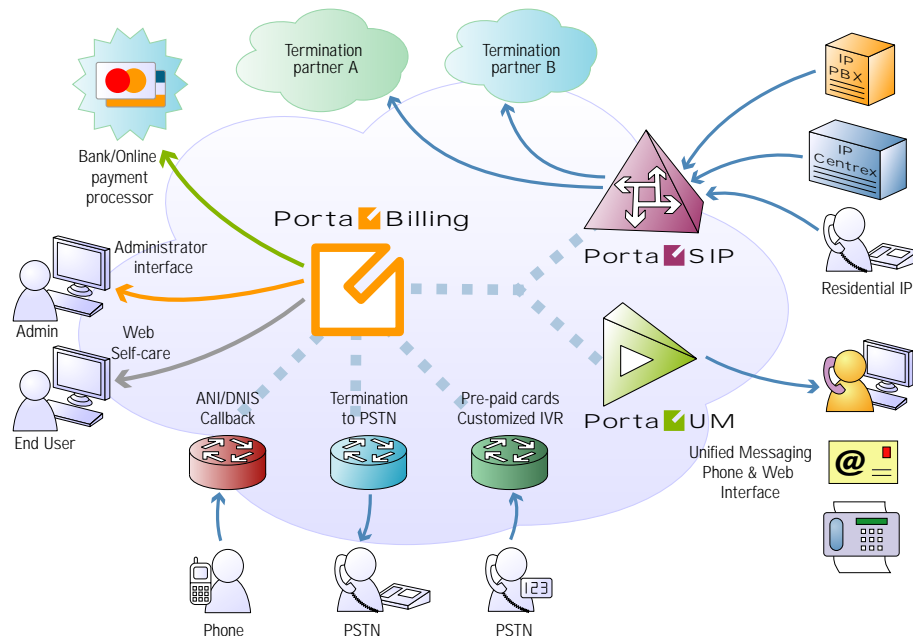

PortaUM handles voice, fax and regular email messages as objects in a single mailbox, which users can access via a web interface or by telephone.

## PortaUM Components

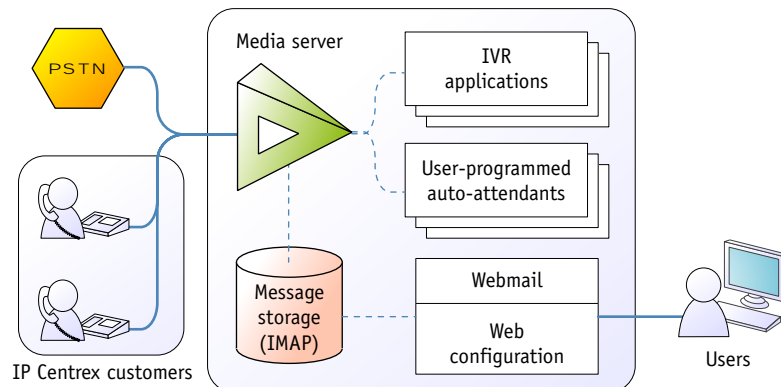

### PortaUM consists of the following main components

- Media server / VXML platform. This component is used to record messages and receive faxes, as well as send them to the PortaUM machine for processing and storing. It also provides users with IVR (interactive voice response), allowing them to listen to and manage recorded messages using a SIP phone. This component can be implemented by:
  - using an external Cisco AS53XX gateway, or
  - using IVR tools built into the PortaUM server itself.
- A web server, used to provide the user with web-based access to his mailbox. The web server is also used, along with special CGI scripts, by the VXML platform to retrieve recorded messages from the PortaUM machine on demand.
- An IMAP server, used as the main storage for messages.
- A database server, providing storage for the user's custom settings and voice prompts.
- An SMTP server, used to receive incoming messages from the VXML platform and other SMTP servers, as well as to send outgoing messages created by the user on the web interface.
- A mail filter, used to convert audio and graphic attachments in messages received from the VXML platform in a format compatible with the Microsoft Windows operating system.



# PortaUM Clustering

## PortaUM Stand-by

To enable quick service recovery on the PortaUM server in case of hardware problems, you can set up a second physical server to act as a stand-by.

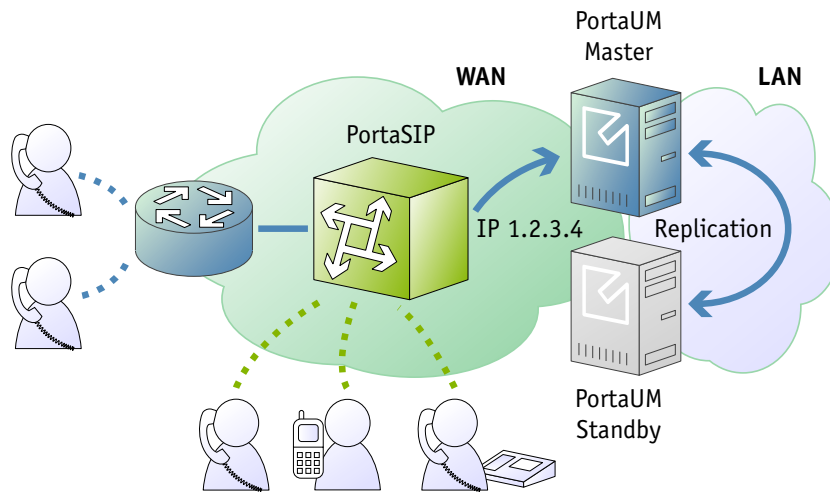

Connected via a private LAN to the primary PortaUM server, the stand-by server constantly replicates all changes made (new messages, user preferences, auto attendant configuration, etc.). If the main server goes down due to a hardware problem, the stand-by server can simply take over the primary server's IP address and begin operating as a new primary.

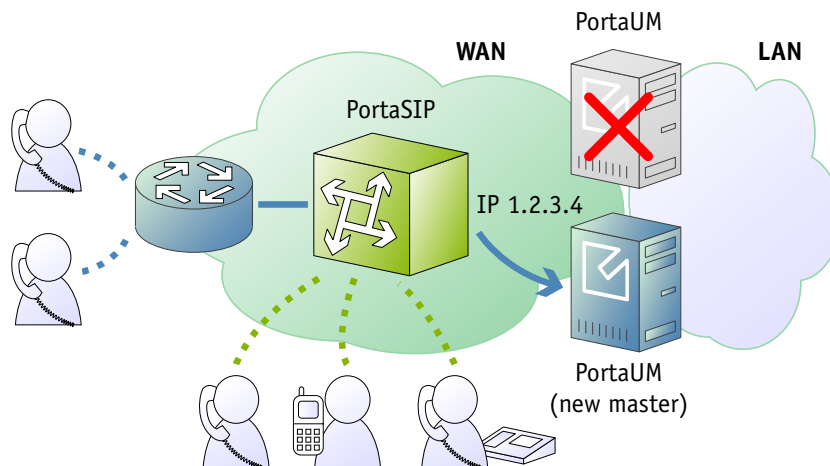

This ensures primary/stand-by switchover without the need for any network, IP phone or PortaSwitch reconfiguration.

## Distributed PortaUM

Although the PortaUM license does not limit the number of mailboxes or IVR sessions, there are some limitations based on CPU processing power, disk space, or other hardware parameters. Should your business require more UM mailboxes or concurrent IVR sessions than a single PortaUM server can handle, you may use several PortaUM servers to distribute your customers or IVR calls between them.

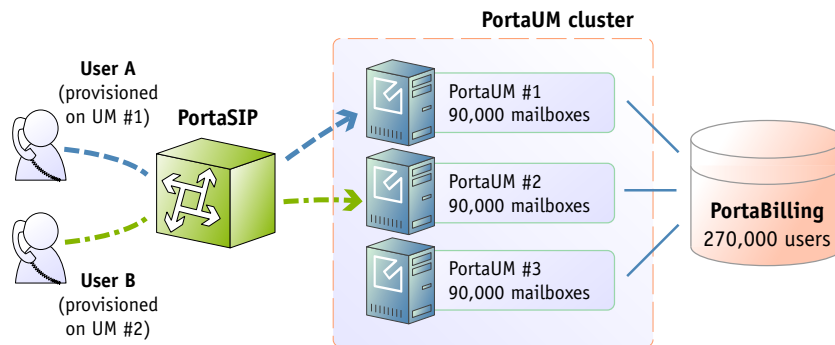

When a cluster of PortaUM servers is deployed, and the UM service has been enabled for a certain account, PortaBilling100 will automatically provision the user's mailbox on one of the available PortaUM servers. (The administrator can override these settings, if necessary, and manually assign a mailbox on a specific server to a given account.) When a call to this account is to be forwarded to the mailbox, or when the account owner dials a PortaUM self-care IVR, the call is automatically forwarded to the specific PortaUM server handling this account. For services which do not require association with a specific mailbox (e.g. prepaid card IVR), and so can be handled by any available server, incoming calls are forwarded to PortaUM servers in the cluster in a "round-robin" fashion. This ensures both load-sharing between servers (each server receives only a certain portion of all calls) and call failover (if one server is down, calls will go to the others).

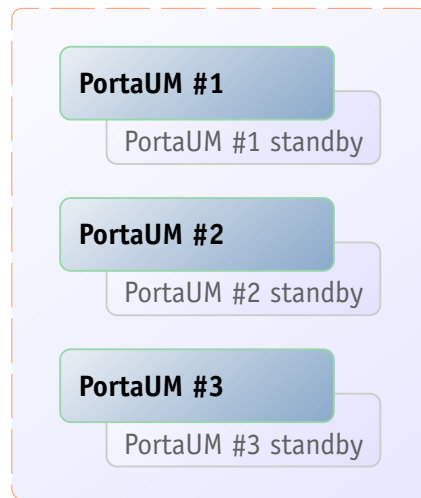
**PortaUM cluster**

Of course, you can combine the distributed and standby approaches by creating a PortaUM cluster where the total load is spread among several PortaUM servers, each of which has its own standby server for failover purposes.

## Conceptual Elements

### Mailbox

A mailbox is a portion of disk space on the PortaUM server which has been allocated for storing messages. Messages can be voice messages, faxes, or generic emails. You may set a quota (maximum allowed disk space) for user mailboxes, to prevent a situation where some users store too much information in their mailboxes, thus creating problems because the disk space is unavailable for other customers.

### IVR Scenarios

When PortaUM answers an incoming call, an IVR (Interactive Voice Response) application is deployed. This application defines how the call is to be further processed, i.e. what the user on the other end will hear. PortaUM IVR applications include, among others:

- Voicemail, allowing callers to leave a message which will be delivered to the user's mailbox;
- Fax-to-email;
- Auto attendant – a custom-designed set of voice menus (see below for more details);
- Check balance/top-up account;

- Prepaid card.

## Auto Attendant

PortaUM's auto attendant is a flexible utility designed to provide IVR for callers and allow them to navigate among different options by pressing keys on their phones. Auto attendant capabilities include simple features such as playing a certain voice prompt to the end-user or collecting his input, as well as more advanced features such as incoming fax detection or call queues.

## Call Process

SIP UA <-> SIP UA

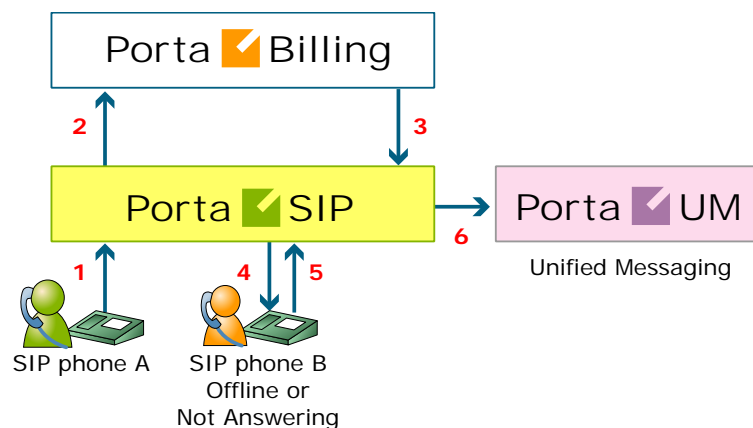

- User A dials 121 in an attempt to reach user B. A's SIP user agent sends an INVITE request to the SIP server (1).
- The SIP server performs authorization in the billing (2). For example, if A dialed 121, the billing will inform the SIP server that the actual number is 12027810009, and that this number belongs to B (3).
- The SIP server checks the registration database, but it appears that this account is not online at the moment. If B has Unified Messaging services enabled, the call will be redirected to the voicemail system, and A can leave a message for him (6). The same thing would happen if B were online, but did not answer his phone (4), (5).

## SIP UA -&gt; PSTN

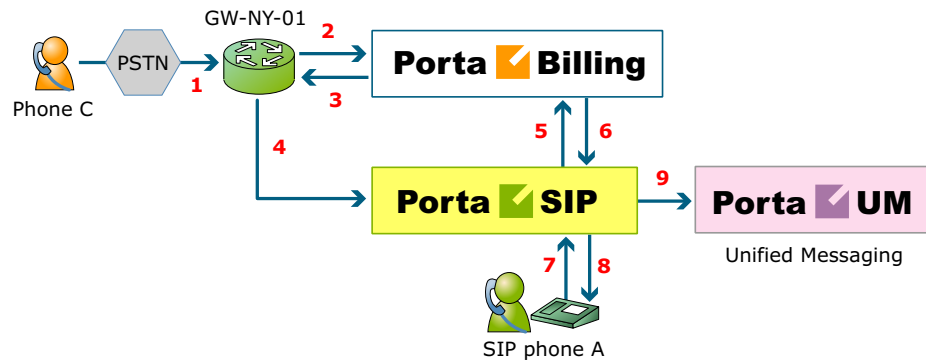

This is another important aspect of SIP telephony. Your subscribers not only want to make outgoing calls, they also want other people to be able to call them on their SIP phone regardless of where they are at the moment.

In order to allow this, you will need to secure a range of phone numbers from your telecom operator, and make sure that calls made to these numbers on the PSTN network are routed to your gateway via the telephony interface.

- User C wishes to call user A. He dials A's phone number; since C is in the USA, he dials it in North American format, i.e. 2027810003.
- The call is routed through the telecom network to gateway GW-NY-01. When the incoming call arrives on the gateway (1), it starts a special TCL application to handle this call. This application does several things:
  - Converts the phone number to E.164 format, so that 2027810003 becomes 12027810003.
  - Performs authorization in the billing (2), i.e. checks whether A is allowed to receive incoming telephony calls from GW-NY-01 and, if you charge for incoming calls, what is the maximum allowed call time based on A's current balance (3). One important point is that authorization must happen without a password check, since the application does not know the valid password for the SIP account.
  - Starts the outgoing call to 12027810003.
  - When the call is established, it starts the timer, and will disconnect the call if the maximum call duration is exceeded.
  - The gateway is configured so that it knows that calls to 1202781.... numbers should be sent to the PortaSIP server. Thus it sends an INVITE to the PortaSIP (4).
- PortaSIP receives the INVITE, but without authorization information. Thus the PortaSIP server performs authentication

based on the IP address (5), (6). Since this call comes from a trusted node, i.e. gateway GW-NY-01, it is authorized.

- The SIP server checks its registration database, but it appears that this account is not online at the moment. If A has Unified Messaging services enabled, the call will be redirected to the voicemail system, and C can leave a message for him (9). The same thing would happen if A were online, but did not answer his phone (7), (8).

## Auto Attendant

### Basic Concept

- PortaUM's auto attendant is composed of a set of menus.
- All the menus are identical in every respect, except for the **ROOT** menu, which is always present and cannot be deleted, and whose name cannot be changed.
- When a caller dials the system, auto attendant will answer (connect) the call and proceed to the **ROOT** menu.
- If a user tries to access a menu which is not currently active, the action specified in the **Not Active** configuration parameter will be performed; for instance, the user may be automatically forwarded to an "after hours" menu.
- The **Intro** prompt (e.g. "Welcome to PortaOne, a VoIP solutions company!") is played when a user enters a menu for the first time.
- After this, the **Menu** prompt will be played, listing all the available options (e.g. "Press 1 for sales, press 2 for technical support"), and auto attendant will collect the digits dialed by the user on his phone touchpad.
- If no input is received (timeout), the **Default** prompt is played and the dialog reverts to the previous step (i.e. plays the **Menu** prompt and collects the user's input).
- The user's input will be matched with the corresponding menu items, and the action associated with this item will be performed. The following actions are possible:
  - o **Default** – Plays the **Default** prompt from the current menu and returns to the "Play **Menu** prompt" step (this is the action used for all menu items where the initial value has not been modified).
  - o **Transfer** – Transfers the call to a given telephone number or extension. The phone number should be entered in the same format as the customer would use to dial it from an IP phone in his IP Centrex environment; for example, to transfer a call to extension 123, simply enter 123.

- **Transfer to E.164 Number** – Transfers the call to a given number. The number should be specified in E.164 format: the country code, followed by the area code, and then the number (e.g. 16045551234 for Canada).
  - **Transfer to Extension** – Transfers the call to an extension number entered by the caller from his phone. To prevent abuse (e.g. someone attempting to enter a long-distance number in this way), you can specify the maximum allowed number of digits in an extension (**Max Size**).
  - **Transfer to Voicemail** – Switches to voicemail mode. This should be designated as an action for the “Fax” event, in order to allow storage of received faxes.
  - **Menu** – Transfers the user to the selected menu.
  - **Directory** – Launches this company’s dial-by-name directory.
  - **Queue** – Transfers the call to the specified call queue.
- You may select whether the corresponding **Before Action** prompt is to be played prior to the action.
  - A call menu flow chart is shown in the diagram below.

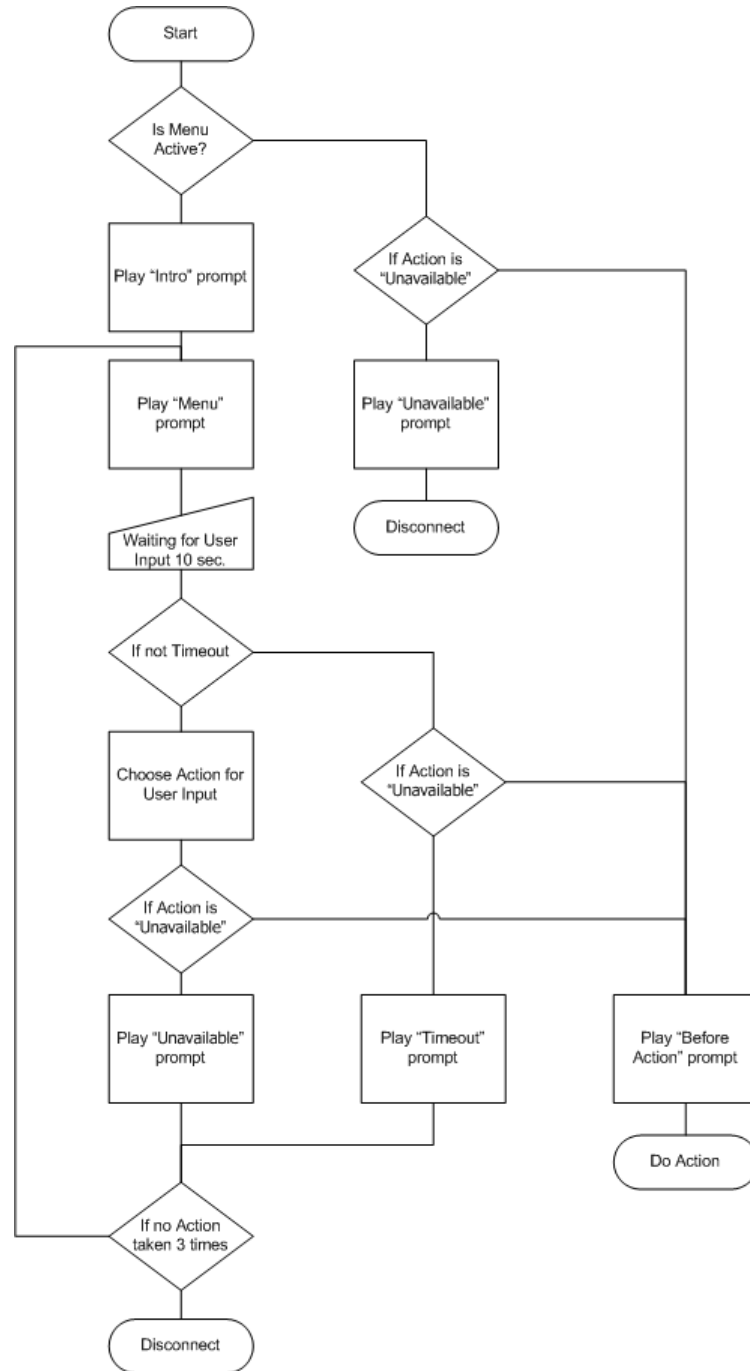

## Menu List Mode

Auto attendant can be selected from the Options menu. The main screen lists all the menus available in the system.

To modify one of the existing menus, select its name from the list. To add a new menu, select  **Add** from the action panel.

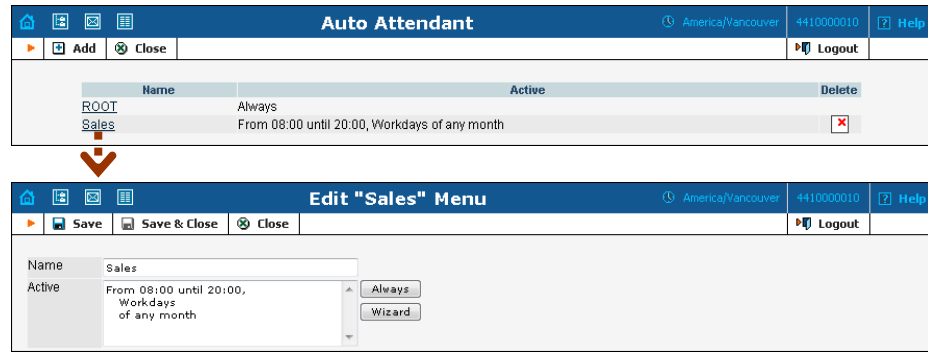

## Menu Edit Mode

After selecting one of the existing menus, please allow all the prompts to load in your browser; this may be viewed on the status indicator in the action pane.

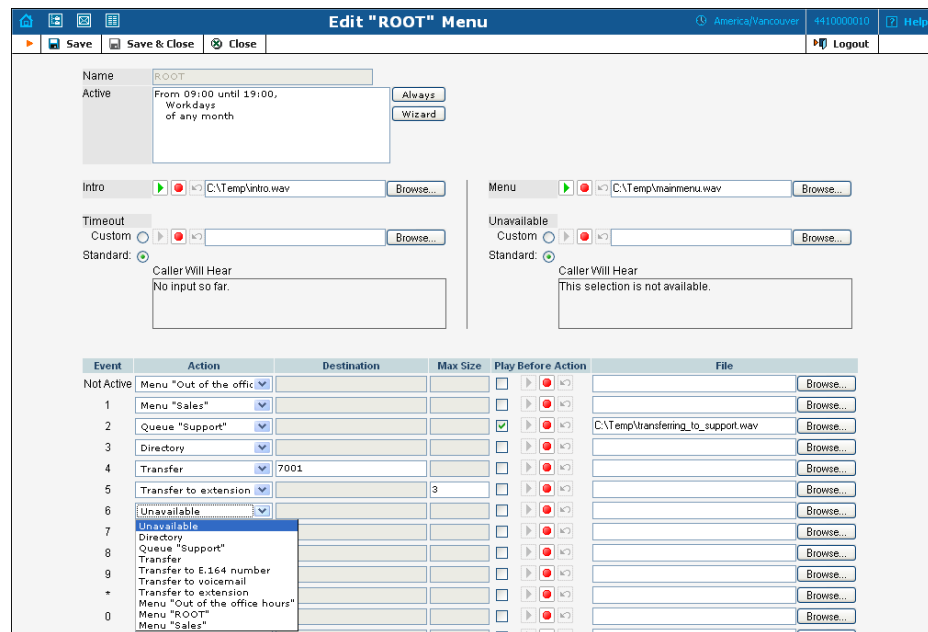

The fields of the Menu Edit screen are explained below:

### Name

A logical name for the menu, i.e. **Sales** for a sales department.

### Active

Time definition for when the current menu is active. To set the menu as always active, select the **Always** button on the right. PortaUM also provides users with a Period Wizard, a flexible tool for defining a time period of any complexity.

## Period Definition Wizard

Via a series of screens, the user may select a time interval, day of the week, day of the month, and month; multiple selections are allowed.

The following example shows how to create a period starting at 6 pm every day and lasting until 6 am the next morning. Another interval is used on weekends. We will also include some holidays, e.g. January 1 and December 24-26.

In the first screen, select 6 pm in the **From** column and 6 am in the **Until** column. Now select the **Next** button. The two text areas on the right side of the screen provide the user with a display of the current period definition. The top text area displays a verbal definition of the period: From 6:00pm until 6:00am, while the bottom one contains the same information in a format which can be parsed by PortaBilling: `hr{6pm-5am}`. This sets up the first period; in order to continue, skip the following screens by pressing the **Skip** or **Next** button, until the **Period definition completed** message is displayed. Click **Add** to create another period definition, and the wizard will return to the first screen.

Now for weekends: by pressing the **Skip** or **Next** button, go to the second screen and select *Weekend*, or hold the <Ctrl> key and select *Saturday* and *Sunday* from the list. Now use the **Next** button, skipping forward until the **Period definition completed** message is displayed. Click **Add** to create another period definition.

To include January 1st in the period definition, skip to the Day of the Month screen and select *1*. Now click the **Next** button. Select *January* and click **Next**, skipping forward until the **Period definition completed** message is displayed. Follow the same steps to select the December 24-26 interval. Hold the <Ctrl> key to select multiple entries.

To review your work, look at the top text area. The following should be displayed:



```
From 6:00pm until 6:00am
  any day of any month
OR Sunday and Saturday
  of any month
OR 1
  of January
OR 24-26
  of December
```

If the definition is correct, select **Finish**.



**Intro, Menu, Timeout, Unavailable**

You can define four separate prompts (see previous section for an explanation of when each particular type of prompt is played). While you will need to provide content for the **Intro** and **Menu** prompts, you can use the default content for the **Timeout** and **Unavailable** prompts.

 - **Record**. Select to start recording your voice prompt. (You will need to connect a microphone to your computer's sound card to use this feature.)

After the existing prompt has been recorded over, the  **Undo** icon becomes available, allowing rollback to the previous state. The blinking  **Play** icon indicates that the existing prompt is being overwritten, but changes have not been saved yet.

 - **Stop**. Select this to stop recording or playback of the recorded message.

 - **Play**. Select this to play back the recorded prompt. When selected, this icon will turn into  - **Pause**.

Each of the icons above may appear in grayscale, meaning it cannot be accessed because some other task is active.

To give your auto attendant a professional sound, we recommend using a professional speaker and a digital recording studio when recording voice prompts.

To upload a prompt, select the **Browse...** button on the right side. The native audio file format for the system is the following:

**Type:** NeXT/Sun (Java) file .au

**Format:** G.711 u-Law

**Attributes:** 8,000 Hz, 8-bit, Mono

PortaUM uses **SOX - Sound eXchange**, a universal sound sample translator for prompts uploaded into native UM format.

Here is a short list of supported audio file formats:

Type	Description
.aiff	AIFF files used on Apple IIc/IIgs and SGI.
.au	SUN Microsystems AU files.
.gsm	GSM 06.10 Lossy Speech Compression
.mp3	MP3 Compressed Audio
.ogg	Ogg Vorbis Compressed Audio.
.raw	Raw files (no header).

.wav	Microsoft .WAV RIFF files.
------	----------------------------

Event Table

Column	Description
Event	<p><b>Not Active</b> – When the current menu is not active (see the active period definition above).</p> <p><b>0-9, #, *</b> – User selection on telephone keypad.</p> <p><b>Timeout</b> – No selection received from user.</p> <p><b>Fax</b> – Fax CNG tone detected.</p>
Action	See the description of available actions in the <i>Basic Concept</i> section above.
Play before action	Check this box if the corresponding prompt is to be played before an action is performed.
File	File name and path for the prompt file.

## Call Queues

This feature allows you to provide a “call center” functionality to your IP Centrex customers. When a large number of incoming calls from customers arrive to the auto attendant, PortaUM can forward these calls to the actual agents (customer service representatives) in a regulated fashion.

Every call queue contains several configuration parameters:

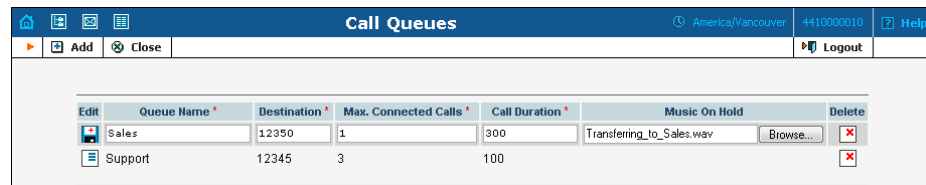

- **Destination** – A phone number where an outgoing call may be forwarded to. The fact that this is a single number does not, of course, mean that you can only have one agent answering calls. This is simply the number used to forward calls to PortaSIP. On the PortaSIP side, you can use the call forwarding feature to direct an incoming call to multiple IP phones. Or, alternatively, you may forward this call to an external IP PBX or a gateway with multiple FXS ports; then “hunting” for an available agent will be done on that side.
- **Max Connected Calls** – This defines the “bottleneck” of your queue, i.e. the maximum number of concurrently connected outgoing calls.
- **Call Duration** – The average expected processing time for each call (used to calculate the estimated waiting time).

- **Music on Hold** – A melody (or announcement) which is played to users waiting to be connected.

Each call queue contains a pool of incoming calls (users trying to get connected) and a number of connected outgoing calls (calls that have already been connected to agents). When a new incoming call arrives, it is assigned a position in the queue. The caller will hear an announcement about his position in the queue and the estimated waiting time, which is calculated as (average call duration) / (maximum number of connected calls) \* (total number of users before him in the queue). After that, the specified “music on hold” is played, and every minute the caller is updated as to his current position in the queue and the estimated waiting time.

If there are callers on hold and the number of connected outgoing calls is lower than the specified threshold, PortaUM will attempt to connect the first person in the queue. A call invitation is sent to the destination number in PortaSIP, and PortaUM waits until the call is answered by the other side. If the call is not connected on the first attempt (some representatives may not be available at the moment), PortaUM will make another attempt, then another one, and so on. This will continue until either all of the incoming calls are connected, or the maximum threshold for outgoing calls is reached. In the latter case, PortaUM will simply wait until one of the agents finishes serving his current customer, thereby disconnecting one call and making “room” for a new outgoing call.

## Dial-by-name Directory

This is another element of the auto attendant IVR functionality. If a caller does not know the extension number of the person he is trying to reach, he may look up the called party using the first three letters of his surname.

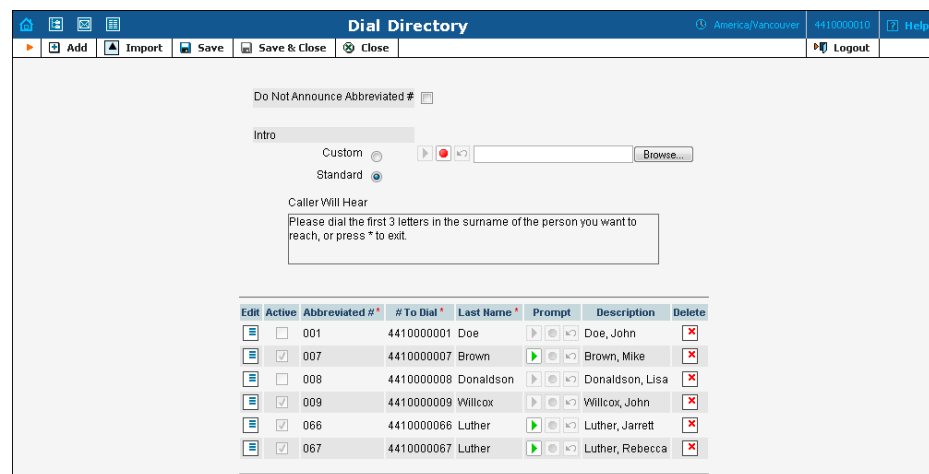

Edit	Active	Abbreviated #	# To Dial	Last Name	Prompt	Description	Delete
<input type="checkbox"/>	<input type="checkbox"/>	001	441000001	Doe		Doe, John	
<input checked="" type="checkbox"/>	<input checked="" type="checkbox"/>	007	441000007	Brown		Brown, Mike	
<input type="checkbox"/>	<input type="checkbox"/>	008	441000008	Donaldson		Donaldson, Lisa	
<input checked="" type="checkbox"/>	<input checked="" type="checkbox"/>	009	441000009	Willcox		Willcox, John	
<input checked="" type="checkbox"/>	<input checked="" type="checkbox"/>	066	441000066	Luther		Luther, Jarrett	
<input checked="" type="checkbox"/>	<input checked="" type="checkbox"/>	067	441000067	Luther		Luther, Rebecca	

Every UM account has its own dial-by-name directory; however, an initial list of extensions may be imported from the main list in PortaBilling to save time and effort. You can upload a voice prompt with the actual person's name for each extension. You may also exclude certain extensions from being accessible via dial-by-name (e.g. you do not want tele-marketers to directly reach your CEO or CFO because their names are publicly accessible).

The dial-by-name directory can be assigned as an "action" item to any element in the ROOT menu or sub-menu. When a user reaches the dial-by-name dialog, he will be prompted to enter the three first letters in the called party's surname. Standard phone mapping is used, i.e. 2 is ABC, 3 is DEF, and so on. If no matching person is found, the user is informed of this, and may then re-enter the name or press \* to exit. If more than one match is found (e.g. there are two persons with the "same" surname in the company, e.g. 276 will match both Brown and Asok), the user will hear a list of matching names and their extensions, and may then enter the correct extension.

Two modes of selecting the call transfer destination are available:

- The end-user hears the person's full extension (e.g. "Press 116 to reach John Brown, press 145 to reach Mary Broslavsky") and then enters it, thus learning the actual extension number for future use.
- If, for some reason, the actual extension numbers are to be hidden from end-users, then another mode is available. In this case, users can choose a person simply by dialing a sequential number from a list (i.e. the announcement in the previous example will now be: "Press 1 to reach John Brown, press 2 to reach Mary Broslavsky").

## Supported Services

### Leaving voice messages for a PortaUM user

PortaUM gives your SIP customers an automatic answering machine whenever they are not online or do not answer within a certain (configurable) time period. This service works when a call comes from PSTN, as well as when it comes from another SIP customer. See the Call Process section above for detailed call flow descriptions.

### Fax-to-email services

In addition to voice messages, UM-enabled SIP customers will be able to receive faxes on their "answering machine". When a call is connected to PortaUM and the remote party initiates a fax transmission, PortaUM automatically detects this event and switches into fax receiving mode. The

fax will be processed and then delivered to the user's mailbox as a .PDF or .TIFF document attached to an email message.

### Sending email messages to a PortaUM user

PortaUM also allows your SIP customers to have regular email accounts, where they can receive regular emails.

### Retrieving voice and email messages using a SIP phone

Your SIP customers will be able to retrieve their messages using a SIP phone. To do this, they must dial a special number, which transfers them to the PortaUM IVR menu. This menu allows them to listen to recorded messages. Additionally, for SIP phones that support a message waiting indicator (MWI), PortaUM can automatically manage the SIP phone's MWI status, so that the user is notified when he has new messages in PortaUM.

### Retrieving voice messages, email messages and faxes using a web browser

Users can retrieve their messages and send regular email messages using a standard web browser. The advanced Java applet built into the interface allows users not only to listen to voice messages, but also to compose new voice messages (a microphone is required). It is also possible to access the system using any email client that supports the IMAP or POP3 protocols.

### Forwarding messages to an external email server

When a new message arrives in the PortaUM message storage, a full copy of the message, or just a short notification, can be sent to the user's other email address (e.g. corporate mail server or private gmail account), depending on the user's preferences.

### Managing personal PortaUM settings using a SIP phone

In addition to retrieving messages, your SIP customers can manage their personal PortaUM settings, such as greetings, from a SIP phone using the PortaUM IVR menu.

### Managing personal PortaUM settings using a web browser

Users are also able to manage their personal PortaUM settings by logging into the PortaUM web interface. The advanced Java applet built into the interface allows users to record personal greetings (a microphone is required).

### Managing your current balance

PortaUM users can listen to the current state of their accounts by using the PortaUM IVR menu. There is also an IVR menu enabling the use of vouchers to add funds to an account.

### Prepaid card IVR

PortaUM includes an IVR system that allows you to offer a prepaid card service for incoming VoIP calls. This IVR supports all the PortaBilling extensions for the prepaid card application (access codes, real and announced call duration, and so on).

### Auto attendant

Every user can program his own set of menus for auto attendant, from a simple message such as “I am on vacation right now, press 1 to connect to my assistant” to a complex menu system with various options for small or medium-sized businesses. Users can program the voice dialog from their web browser, record voice prompts using a microphone on their PC or upload professionally recorded prompts, create multiple sub-menus and define an activity period for each of them, program their company’s dial-by-name directory, construct multiple call queues, and so on.

### Voice-to-text Service

PortaUM is now integrated with the **GotVoice** service to provide “visual voicemails” to customers. Once a recorded voice message is delivered to PortaUM, it can be transferred to one of the GotVoice servers for processing. GotVoice uses state-of-the-art technology to recognize message contents, combining computerized speech recognition with live human assistance for those parts which cannot be processed automatically. In a matter of minutes the customer receives an email containing a transcript of the message text. This makes it possible to access the voicemail information via an email client or an SMS sent to a mobile phone.

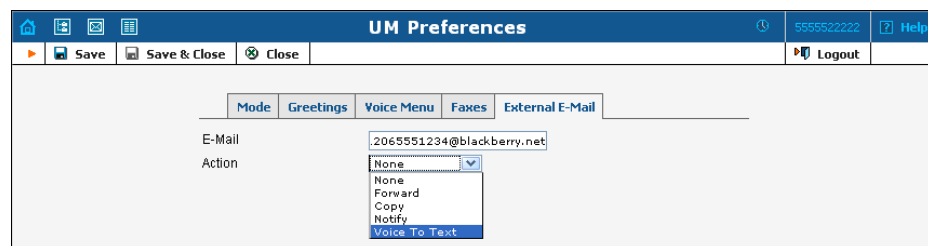

VoIP providers using PortaSwitch can now reliably offer subscribers the ability to read their voicemail and process the information instantly. Using this service requires a contract with GotVoice (in order to be assigned an

account giving access to the conversion API) and the basic PortaSwitch configuration (to create rates for this service, etc.).

An ITSP must sign a contract with GotVoice for voice-to-text service and obtain the username/password information for accessing the conversion API. This information should be provisioned in `porta-um.conf` configuration file on PortaUM.

Since voice-to-text is a paid service, where ITSP is charged for every conversion, charges should be applied to the customer, who is using the service. PortaUM performs authorization in PortaBilling prior to conversion (to verify that the customer has sufficient funds). Once conversion has been completed, it sends a “charge” event to PortaBilling.

# 2. Setting Up and Using UM Services

## Setting Up UM Services

### Initial Configuration of PortaBilling

Before proceeding with UM setup, please perform initial system configuration according to the *Setting up SIP Services* chapter in the [PortaSIP User Guide](#). At this point, all of your destinations, tariffs, products, customers and vendors should already be in the system.

### Creating Special UM Destinations

Your subscribers can access UM by two different methods:

- Dialing a special UM number from their SIP phone. Usually this is a non-E.164 number, so it will not overlap with any real phone number the customer might wish to call, e.g. **\*98**. Another option for accessing UM is for the end user to dial his own phone number.
- Calling a certain number from the PSTN network. This should be a valid phone number allocated to you by a local telco and accessible to anyone on the PSTN network. If you do not have such a number, your customers will not be able to check their voicemail from a regular phone.



Any special UM access number (or numbers) should be defined in the `Numbers` parameter in the `UnifiedMessaging` section of the PortaBilling billing engine configuration file `porta-billing.conf`; for example:

```
[UnifiedMessaging]
Destination=UM
Numbers=*98,*99,1234567890,*11,*12,111222333
```

In either case described above, such calls should be clearly identified in your system as UM calls. So you need to create destinations which describe these phone numbers. The same applies to the special destinations Play Current Balance (**\*11**) and Recharge Voucher (**\*12**).

1. In the Management section of Admin-Index, choose **Destinations**.
2. Click on the  **Add** button.

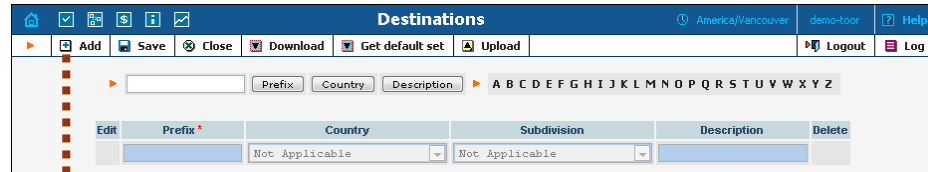

3. Enter your on-net UM number under **Prefix**, and **N/A** for the country and country subdivision. Put a comment in the **Description** column that clearly identifies this as a special prefix assigned to UM.

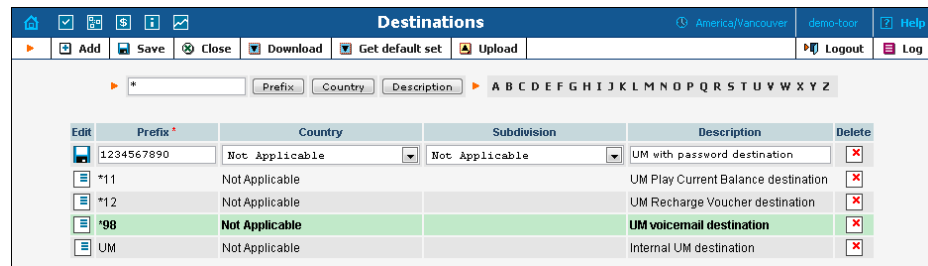

4. Click  **Save**.
5. Add a destination for the PSTN UM number if you have one.
6. Add Play Current Balance destination (optional).
7. Add a destination for Recharge Voucher (optional).

## Create Nodes

Now you have to enter your PortaUM server and UM gateway (used as the platform for VXML) as nodes. PortaBilling requires some key information about your network equipment, such as IP address, h323-id, Radius shared secret, and so on.

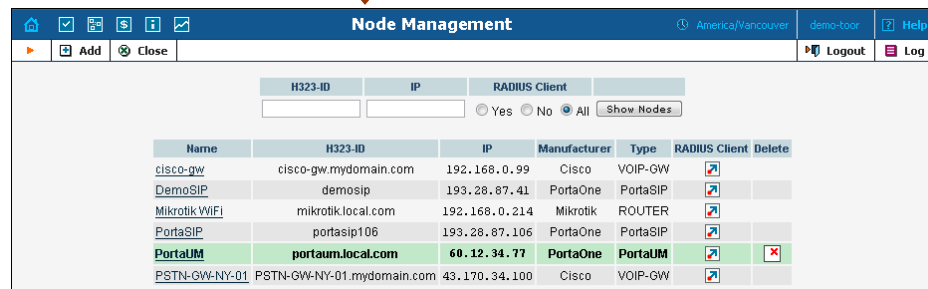
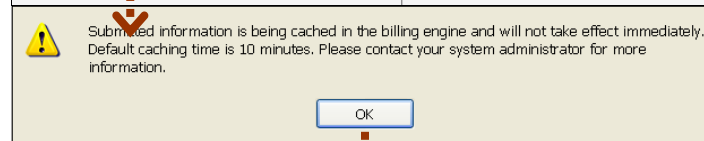
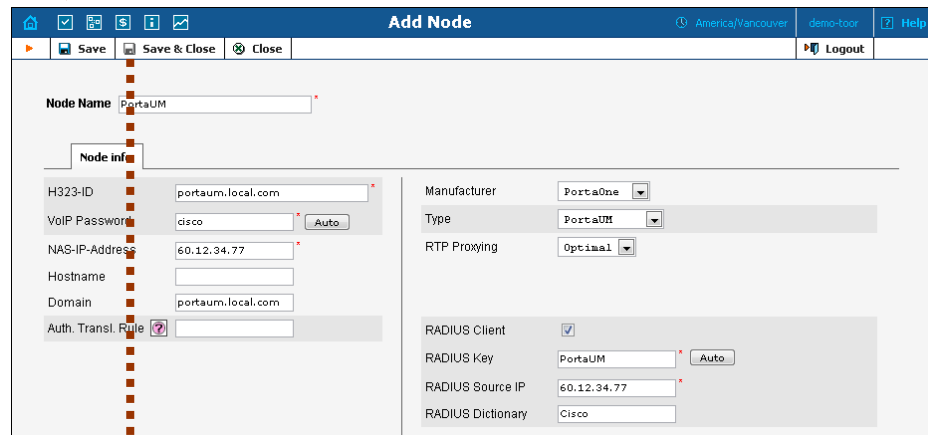
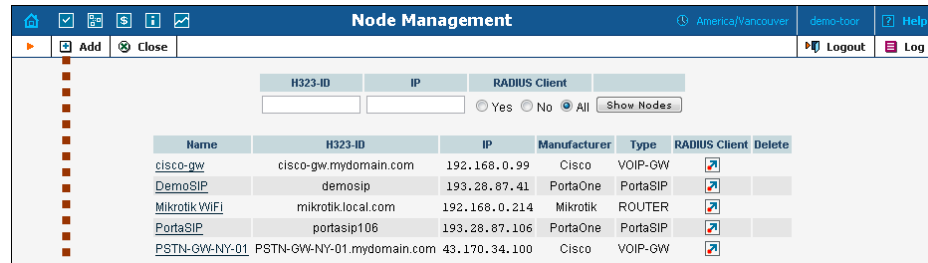

1. In the Management section of the Admin-Index page, choose **Nodes**.
2. In the Node Management window, click **Add** icon.
3. Fill in the New Node form:
  - o **Node name** – A short descriptive name for your UM server or gateway (this will be used in the select menus).



- **H323-ID** – h323-id (recommended: `hostname.domainname`)
  - **H323 Password** – If you plan to send calls from the UM gateway to your Cisco gateways where the default Cisco remote IP authentication script will be used, enter `cisco` here.
  - **NAS-IP-Address** – IP address of the UM gateway or PortaUM server.
  - **Auth. Translation rule** – You can just leave this empty.
  - **Manufacturer** – Select **PortaOne**.
  - **Type** – Node type; select **PortaUM**.
  - **Domain** – Enter the UM email domain, e.g. `um.mydomain.com`. This parameter is very important, since without it authentication requests from PortaUM cannot be processed correctly.
  - **Radius Client** – Check this, since both PortaUM and the UM gateway will need to communicate with the billing.
  - **Radius Key** – Enter the radius shared secret here; must be the same **key** as you entered during PortaUM installation.
  - **Radius Source IP** – See the ***Node ID, NAS IP address, and Radius source IP*** section in the [PortaBilling Administrator Guide](#) for more information. Unless your PortaUM server uses multiple network interfaces, the value here should be the same as the NAS-IP-Address.
4. Click  **Save&Close**.

**NOTE:** There is some propagation delay between the database and the Radius server configuration file, but no more than 15 minutes.

## Create a Tariff

You have already created all the necessary tariffs (for your customers and vendors) when setting up SIP services. Only one thing remains to be done, i.e. creating a special UM tariff which will be used for routing calls to the UM gateway.



The screenshot shows the 'Tariff Management' interface. At the top, there are navigation icons and the title 'Tariff Management'. Below the title, there are buttons for 'Add', 'Close', and 'xDR Re-rating'. A search bar is present with filters for 'Applied To', 'Service', and 'Managed By', all set to 'ANY'. A table lists existing tariffs:

Name	Currency	Applied To	Service	Managed By	Routing	Description	Rates	Delete
Callback calls	USD	Customer	Voice Calls	Administrator only		Callback		
DID supplier costs	USD	Vendor	Voice Calls		No	DID Supplier		
Pre-paid cards	USD	Customer	Voice Calls	Administrator only		Prepaid cards		

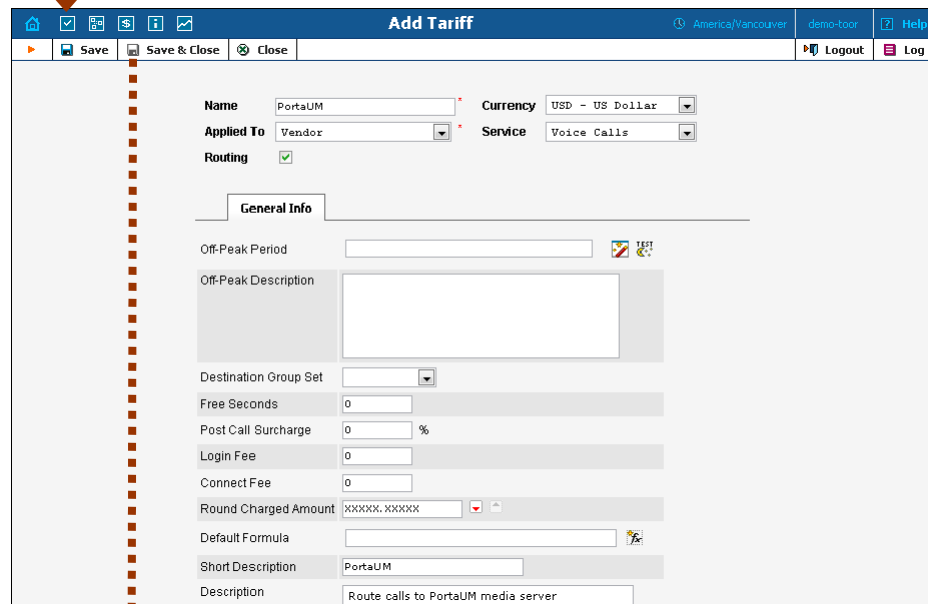

The screenshot shows the 'Add Tariff' form. At the top, there are navigation icons and the title 'Add Tariff'. Below the title, there are buttons for 'Save', 'Save & Close', and 'Close'. The form contains the following fields:

- Name:
- Currency:
- Applied To:
- Service:
- Routing:
- General Info tab is selected.
- Off-Peak Period:
- Off-Peak Description:
- Destination Group Set:
- Free Seconds:
- Post Call Surcharge:  %
- Login Fee:
- Connect Fee:
- Round Charged Amount:
- Default Formula:
- Short Description:
- Description:

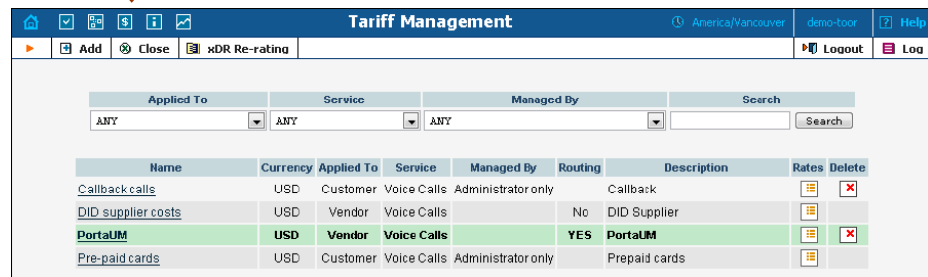

The screenshot shows the 'Tariff Management' interface after the new tariff has been added. The 'PortaUM' tariff is now listed in the table and is highlighted in green. The table is as follows:

Name	Currency	Applied To	Service	Managed By	Routing	Description	Rates	Delete
Callback calls	USD	Customer	Voice Calls	Administrator only		Callback		
DID supplier costs	USD	Vendor	Voice Calls		No	DID Supplier		
<b>PortaUM</b>	<b>USD</b>	<b>Vendor</b>	<b>Voice Calls</b>		<b>YES</b>	<b>PortaUM</b>		
Pre-paid cards	USD	Customer	Voice Calls	Administrator only		Prepaid cards		

1. In the Management section of the Admin-Index, choose **Tariffs**.
2. On the Tariff Management page, choose  **Add**.
3. Fill in the New Tariff form:

- **Name** – A short name for the tariff object. This is the name you will see later in the select menus.
  - **Currency** – Since this is a “fake” tariff, just choose the same currency as your **Base Currency**.
  - **Applied To** – Choose a **Vendor** here, then check the **Routing** check-box below.
  - **Service** – Choose **Voice Calls** here.
  - **Off-Peak Period** – Just leave this field is empty.
  - **Off-Peak Description** – A description of the off-peak period. Automatically provided by the off-peak period wizard, so you do not have to fill in this field.
  - **Destination Group Set** – Do not choose any value in the select menu.
  - **Free Seconds, Post Call Surcharge, Login Fee, Connect Fee, Default Formula** – Leave all these parameters empty.
  - **Short Description** – A short tariff description; enter “PortaUM routing” or something similar.
  - **Description** – An extended tariff description.
4. Click  **Save&Close**.

## Enter Rates

### Modifying tariffs for SIP users

First of all, you should make sure that your customers are allowed to call voicemail. In order to do so, you should add a rate for calling the special voicemail number into the tariffs used for your SIP subscribers.



Applied To	Service	Managed By	Search
ANY	ANY	ANY	Search

Name	Currency	Applied To	Service	Managed By	Routing	Description	Rates	Delete
DID supplier costs	USD	Vendor	Voice Calls		No	DID Supplier		
PortaUM	USD	Vendor	Voice Calls		Yes	PortaUM		
Pre-paid cards	USD	Customer	Voice Calls	Administrator only		Prepaid cards		
SIP Phone Subscribers	USD	Customer	Voice Calls	Administrator only		SIP Phone Subscriber's Tariff		
Termination services	USD	Customer	Voice Calls	Administrator only		Termination services		



Effective From:  Destination:

Now  Prefix:  Group:  Country:

Ed	Destination *	Country	Description	Interval, second		Price, USD/ minute		Effective From	Delete
				First *	Next *	First *	Next *		
	UM		Peak	<input type="text"/>	<input type="text"/>	<input type="text"/>	<input type="text"/>	YYYY-MM-DD HH24:MI:SS *	
			Off-Peak	<input type="text"/>	<input type="text"/>	<input type="text"/>	<input type="text"/>	immediately	

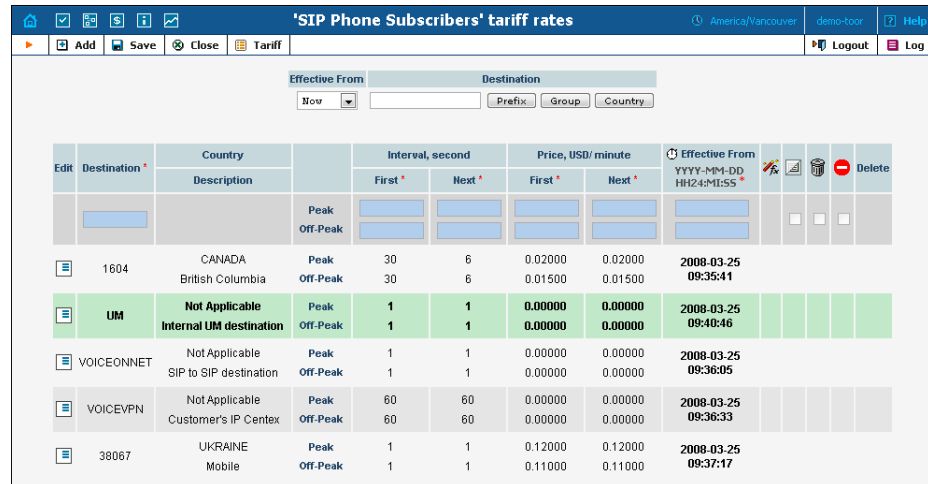



Edit	Destination *	Country	Description	Interval, second		Price, USD/ minute		Effective From YYYY-MM-DD HH24:MI:SS *	Delete
				First *	Next *	First *	Next *		
			Peak						
			Off-Peak						
	1604	CANADA British Columbia	Peak	30	6	0.02000	0.02000	2008-03-25 09:35:41	
			Off-Peak	30	6	0.01500	0.01500		
	UM	Not Applicable Internal UM destination	Peak	1	1	0.00000	0.00000	2008-03-25 09:40:46	
			Off-Peak	1	1	0.00000	0.00000		
	VOICEONNET	Not Applicable SIP to SIP destination	Peak	1	1	0.00000	0.00000	2008-03-25 09:36:05	
			Off-Peak	1	1	0.00000	0.00000		
	VOICEVPN	Not Applicable Customer's IP Centex	Peak	60	60	0.00000	0.00000	2008-03-25 09:36:33	
			Off-Peak	60	60	0.00000	0.00000		
	38067	UKRAINE Mobile	Peak	1	1	0.12000	0.12000	2008-03-25 09:37:17	
			Off-Peak	1	1	0.11000	0.11000		

- On the Tariff Management page you will see a list of the available tariffs. Click the **Rates** icon next to the name of a tariff. When you are in Tariff Management for a particular tariff, click on **Rates** in the toolbar.
- On the **Edit Rates** screen, click **Add**.
- Fill in the required information:
  - Destination** – The special ‘UM’ destination prefix for voicemail which you created earlier.
  - Interval First** – First billing unit in seconds.
  - Interval Next** – Next billing unit in seconds.
  - Price First** – Per-minute price for first interval.
  - Price Next** – Per-minute price for next interval.
  - Off-peak Interval First**– First billing unit in seconds for off-peak time.
  - Off-peak Interval Next** – Next billing unit in seconds for off-peak time.
  - Off-peak Price First** – Per-minute price for first interval of off-peak time.
  - Off-peak Price Next** – Per-minute price for next interval of off-peak time.

**NOTE:** Off-peak fields appear only if an **off-peak period** has been defined for the tariff.

- Effective From** – If you want the rate to take effect sometime in the future, you can either type in a date manually, or use the calendar (click on the DD-MM-YYYY link).

**NOTE:** When using the calendar, you can specify that the date entered be in a different time zone than your current one. PortaBilling will then automatically adjust the time.



- **Rate Formula Wizard**  – You can define a complex rating formula for calls to this destination. For UM calls you do not need complex rating, so just leave this empty.
  - The **Hidden**, **Forbidden** or **Discontinued** flags are optional.
4. Click the  **Save** button in the toolbar or the  icon on the left side of the row.
  5. Click **Close** to return to the Tariff Management screen.
  6. Repeat steps 1-5 to add rates for the UM prefix for all tariffs where you would like customers to have voicemail.

### Rates for UM vendor tariff

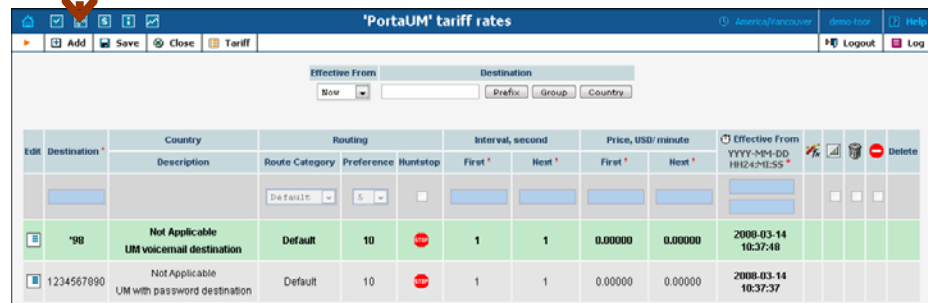
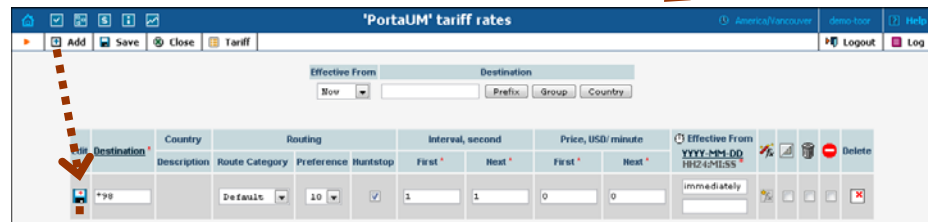
1. On the Tariff Management page you will see a list of the available tariffs. Click the **Rates** icon next to the name of the UM vendor tariff.



2. On the **Edit Rates** screen, click  **Add**.
3. Fill in the required information:
  - **Destination** – The destination prefix for voicemail which you created earlier.
  - **Route Category** – Leave “Default” here.

- **Preference** – Enter 10 in this field. This is the highest routing priority, since calls to voicemail should always be routed to the UM gateway.
  - **Huntstop** – Check this box, since no other route for UM is used except a direct call to the UM gateway.
  - **Interval First** – First billing unit in seconds.
  - **Interval Next** – Next billing unit in seconds.
  - **Price First** – Per-minute price for first interval.
  - **Price Next** – Per-minute price for next interval.
  - **Effective From** – Leave **immediately** in this field.
  - The **Hidden, Forbidden** or **Discontinued** flags are optional.
4. Click the  **Save** button in the toolbar or the  icon on the left side of the row.
  5. Repeat steps 2-4 for each UM rate (\*11, \*12, etc).
  6. Click **Close** to return to the Tariff Management screen.

## Modify Products

You already created all the necessary products for your customers when setting up SIP services. Only one thing remains to be done, i.e. ensuring that these products are allowed to use UM services. If a product's accessibility includes the PortaUM server, then accounts with this product are permitted to login into UM (via webmail, voicemail, or from their email client).

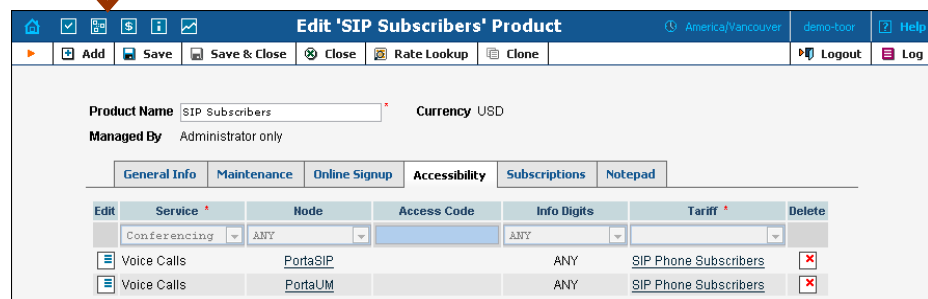
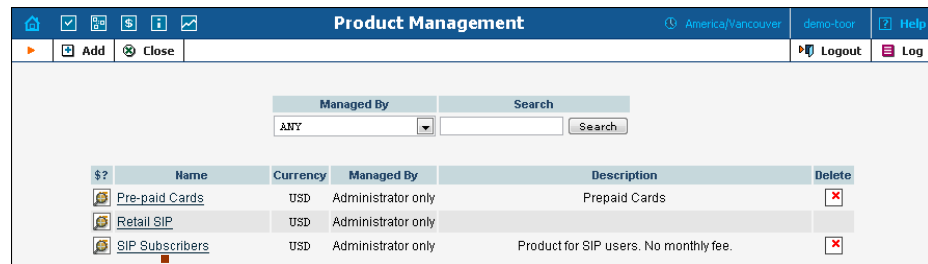

1. In the Management section of the Admin-Index page, choose **Products**.
2. On the Product Management page, click on the name of the corresponding product.
3. Click on the **Accessibility** tab to edit this product's accessibility.
4. After the **Accessibility** tab has been selected, click on the **Add** icon.
5. Choose **Voice Calls** in the **Service** select menu.
6. In the accessibility entry window, select the node which represents your PortaUM server, and choose the appropriate tariff. (The actual tariff is not really important, since users will not be making any calls

- on the PortaUM server. It is best to choose the same tariff which is used to charge outgoing SIP calls.)
7. Click  **Save** to save this accessibility entry.
  8. Click **Close** to return to the Product Management page.
  9. Repeat steps 2-8 to modify accessibility for all products which will include UM services.

## Create an UM Vendor

In order to route UM calls properly, and also to track statistics for such calls, it is advisable to create a special vendor and not mix it with any real vendors. Or, if you already have a vendor which represents your company (for example, for termination of SIP-to-SIP calls), then skip to **Define Connections**.

1. In the Management section of the admin interface, choose **Vendors**.
2. On the Vendor Management page, choose  **Add**.

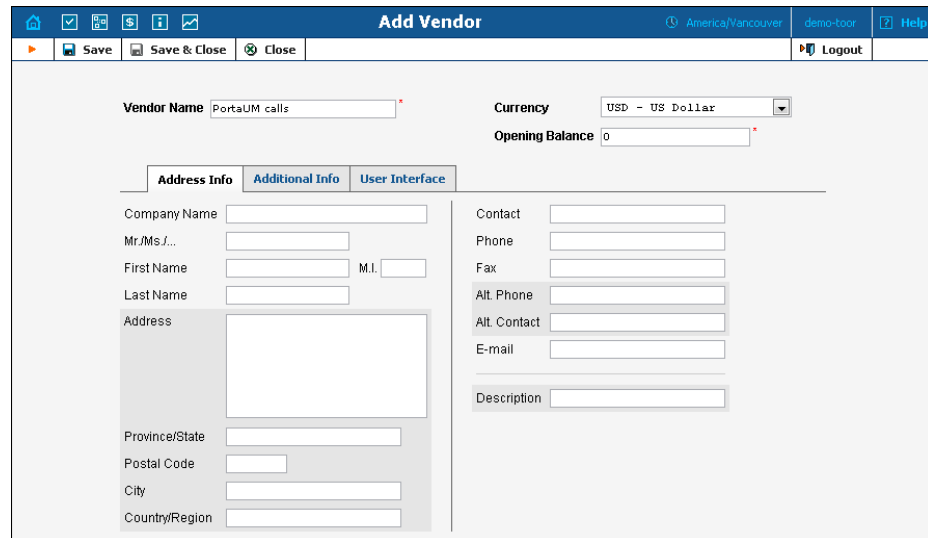

3. Fill in the New Vendor form. Please note that there are two tabs available on the screen. The most important fields are:  
Main form (top):
  - **Vendor Name** – A short name for the vendor object which will be used on the web interface.
  - **Currency** – Enter the currency in which this vendor charges you.
  - **Opening balance** – Starting balance for the vendor; the default is zero.Additional info:
  - **Billing period** – Split period for vendor statistics.
4. Click  **Save & Close**.

## Define Connections

Vendors are your termination partners or providers of incoming toll-free lines.

1. In the Management section of the admin interface, choose **Vendors**.
2. Click on the **Connections** icon next to the name of the vendor you created in the previous step.

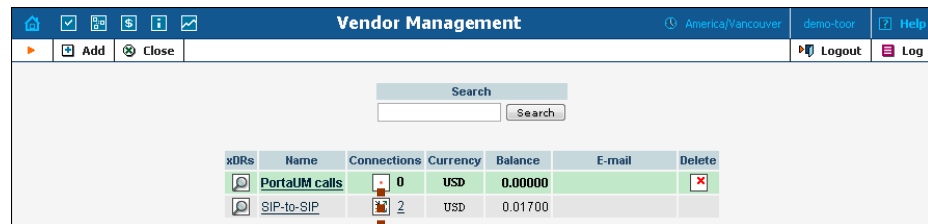

xDRs	Name	Connections	Currency	Balance	E-mail	Delete
	PortaUM calls	0	USD	0.00000		
	SIP-to-SIP	2	USD	0.01700		

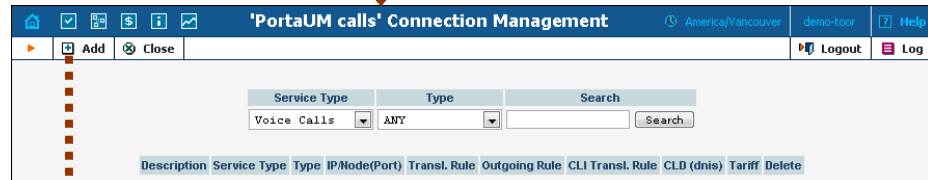

Description	Service Type	Type	IP/Node(Port)	Transl. Rule	Outgoing Rule	CLI Transl. Rule	CLD (dnis)	Tariff	Delete
Calls to PortaUM	Voice Calls	VoIP to Vendor	PORTAUM/60.12.34.77					PortaUM	

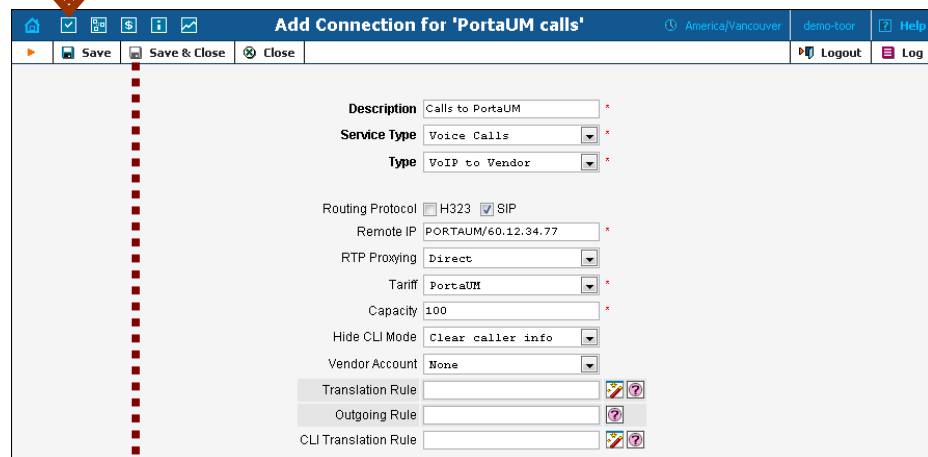

**Description:** Calls to PortaUM  
**Service Type:** Voice Calls  
**Type:** VoIP to Vendor  
 Routing Protocol:  H323  SIP  
 Remote IP: PORTAUM/60.12.34.77  
 RTP Proxying: Direct  
 Tariff: PortaUM  
 Capacity: 100  
 Hide CLI Mode: Clear caller info  
 Vendor Account: None  
 Translation Rule:   
 Outgoing Rule:   
 CLI Translation Rule:

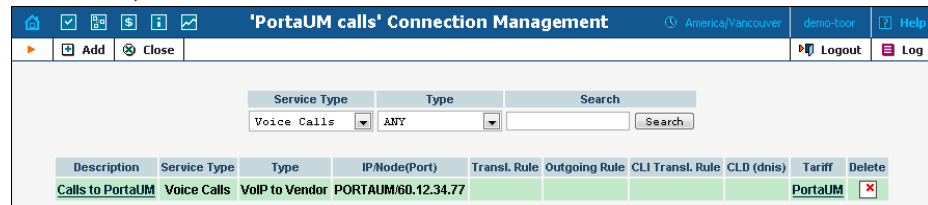

Description	Service Type	Type	IP/Node(Port)	Transl. Rule	Outgoing Rule	CLI Transl. Rule	CLD (dnis)	Tariff	Delete
Calls to PortaUM	Voice Calls	VoIP to Vendor	PORTAUM/60.12.34.77					PortaUM	

3. Press  **Add** to add a new connection.
4. Choose the **VoIP to Vendor** connection type and **Voice Calls** service type by clicking on the corresponding drop-down menu.
5. Fill in the connection information. Type “PORTAUM/x.x.x.x” in the **Remote IP** field, where x.x.x.x is the address of the UM gateway (or the IP address of the PortaUM server itself, if you are using

PortaUM's built-in media server). Choose the PortaUM tariff you created earlier from the select menu in the **Tariff** column. Enter a comment in **Description**, and give the number of simultaneous calls your UM gateway can handle in **Capacity**.



The format of the **Remote IP** field must be "PORTAUM/x.x.x.x" in order for UM to function properly; so if your PortaUM IP address is 193.28.87.37, you would fill in "PORTAUM/193.28.87.37".

6. Click  **Save&Close**.
7. Click **Close** in order to exit to the Vendor Management screen.

## Create Accounts

### Creating new accounts

1. If you are not already there, go to the **Customers** screen (the one containing a list of customers). It should look like the screenshot below.

The screenshot shows the 'Customer Management' interface. At the top, there are navigation icons and a header with 'Customer Management', 'America/Vancouver', 'demo-tool', and 'Help'. Below the header are buttons for 'Add Customer', 'Add Reseller', and 'Close'. A search section includes 'Type' (set to 'Direct Customers'), 'Representative' (set to 'ANY'), and a 'Search' button. The main area is a table with columns: xDRs, Name, Accounts / Subcustomers, Currency, Type, Credit Limit, Balance, E-mail, Status, and Delete. The table lists several customers, including 'ABC Shuttle Ltd.', 'Asgard Telecom', 'Callshop Owner', 'EasyCall Ltd.', 'John - Prepaid', 'Mary Smith', 'Paul Weekes', 'Raj Kumar', 'Shuffle', 'SmartCall SRL', and 'SmartNet'. The 'EasyCall Ltd.' and 'SmartCall SRL' rows have a red warning triangle icon in the Status column.



The screenshot shows the 'Accounts of Retail Customer 'SmartNet'' interface. It has a header with 'Accounts of Retail Customer 'SmartNet'', 'America/Vancouver', 'demo-tool', and 'Help'. Below the header are buttons for 'Add', 'Account Generator', and 'Close'. A search section includes 'Account ID', 'Batch' (set to 'ANY'), 'Ctrl #', 'SIP Status' (set to 'ANY'), and a 'Show Accounts' button. There is also an 'Advanced search' link.



The screenshot shows the 'Add Account for Retail Customer 'SmartNet'' form. It has a header with 'Add Account for Retail Customer 'SmartNet'', 'America/Vancouver', 'demo-tool', and 'Help'. Below the header are buttons for 'Save', 'Save & Close', and 'Close'. The form contains the following fields: 'Account ID' (4410000010), 'Product' (USD - SIP Subscribers), 'Blocked' (checkbox), and 'Opening Balance' (0). Below these are tabs for 'Account Info', 'User Interface', 'Subscriber', 'Additional Info', 'Life Cycle', and 'Service Features'. Under the 'Account Info' tab, there are radio buttons for 'Type' (Debit, Credit, Voucher), a 'Credit Limit' field, a 'VoIP Password' field (aprticof) with an 'Auto' button, an 'E-mail' field, and a 'Batch' field (smartnet-um) with a 'New batch' dropdown menu.

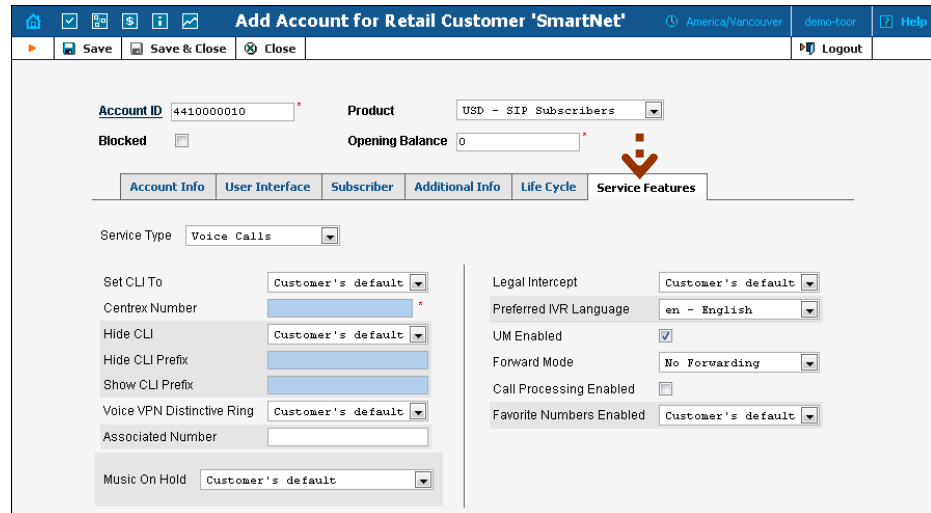

2. Next to the customer name, click on the  icon (the one in the **Accounts** column). This will take you to the account management for that customer.
3. Click on **Add**.
4. Fill in the “Add Account” form:
  - **Account ID** – SIP ID, i.e. the phone number, which will be used to log into the SIP server and receive incoming calls.
  - **Product** – Choose the product which you would like your account to have.
  - **Blocked** – You may create the account as blocked, but this is rarely done with SIP service accounts.
  - **Opening Balance** – The initial balance on the account.

### Account Info

- **Type** – Select credit for postpaid and debit for prepaid service.
- **Credit Limit** – For a credit account, specify the credit limit. If you leave this field empty, this means there is no credit limit for this account (but a customer credit limit may still apply).
- **VoIP Password** – The Account ID and this password will be used to authenticate SIP server login.
- **Email** – Enter the account owner’s email address here. If he ever forgets his password for the web self-care, he will be able to reset it, and a new password will be sent to this email address. You can also leave this field empty.
- **Batch** – A management unit for accounts. The batch name is alphanumeric. You can type a new name here, or use an existing name in order to generate more accounts for the same batch.

### User Interface

- **Login** – Account login to web self-care pages; can be the same as account ID.

- **Password** – Password for web self-care pages.
- **Time Zone** – When an account owner (SIP services subscriber) accesses the web self-care pages to view a list of his calls, the time can be shown in the time zone most appropriate for him.
- **Web Interface Language** – The language to be used on the customer’s self-care web interface.

### Life Cycle

- **Activation Date** – Account activation date.
- **Expiration Date** – Account expiration date.
- **Lifetime** – Relative expiration date; the account will expire on “first usage date” + “lifetime” days. If you do not want to use this feature, leave the field blank.

### Service Features

- **Preferred IVR Language** – This is a custom attribute which is transferred to the IVR. Leave English here if you are unsure whether your IVR supports this function.
  - **UM Enabled** – Check this box if the account has unified messaging services (e.g. voicemail) enabled.
5. Click  **Save&Close**. You will see a confirmation screen saying that a new account has been created.

### Enabling UM services for an existing account

1. If you are not already there, go to the **Customers** screen (the one containing a list of customers). It should look like the screenshot below.
2. Next to the customer name, click on the  icon (the one in the **Accounts / Subcustomers** column). This will take you to the account management for that customer.
3. Type the account ID in the **Account ID** field and click on the **Show Accounts** button.

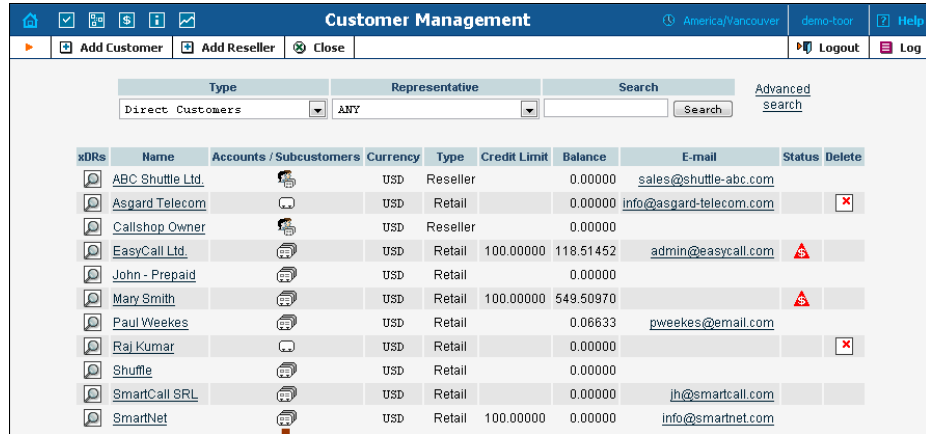

**Customer Management** America/Vancouver demo-tool Help

Add Customer Add Reseller Close Logout Log

Type: Direct Customers Representative: ANY Search: Search Advanced search

xDRs	Name	Accounts / Subcustomers	Currency	Type	Credit Limit	Balance	E-mail	Status	Delete
	ABC Shuttle Ltd.		USD	Reseller	0.00000		sales@shuttle-abc.com		
	Asgard Telecom		USD	Retail	0.00000		info@asgard-telecom.com		X
	Callshop Owner		USD	Reseller	0.00000				
	EasyCall Ltd.		USD	Retail	100.00000	118.51452	admin@easycall.com		⚠
	John - Prepaid		USD	Retail	0.00000				
	Mary Smith		USD	Retail	100.00000	549.50970			⚠
	Paul Weekes		USD	Retail	0.06633		pweekes@email.com		
	Raj Kumar		USD	Retail	0.00000				X
	Shuffle		USD	Retail	0.00000				
	SmartCall SRL		USD	Retail	0.00000		jh@smartcall.com		
	SmartNet		USD	Retail	100.00000	0.00000	info@smartnet.com		

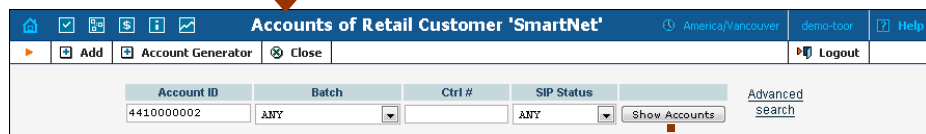

**Accounts of Retail Customer 'SmartNet'** America/Vancouver demo-tool Help

Add Account Generator Close Logout Log

Account ID: 4410000002 Batch: ANY Ctrl #: SIP Status: ANY Show Accounts Advanced search

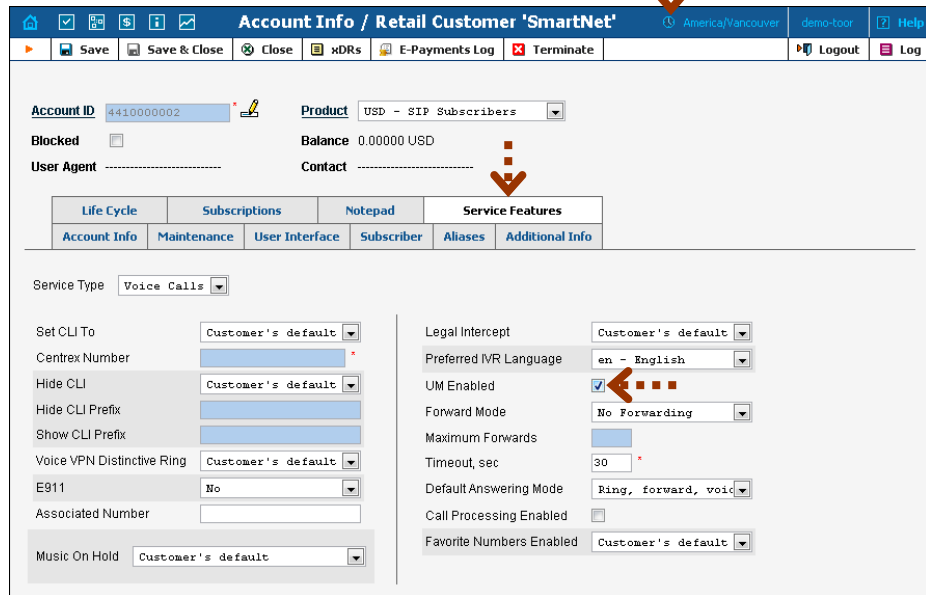

**Account Info / Retail Customer 'SmartNet'** America/Vancouver demo-tool Help

Save Save & Close Close xDRs E-Payments Log Terminate Logout Log

Account ID: 4410000002 Product: USD - SIP Subscribers

Blocked:  Balance: 0.00000 USD

User Agent: Contact:

Life Cycle Subscriptions Notepad **Service Features**

Account Info Maintenance User Interface Subscriber Aliases Additional Info

Service Type: Voice Calls

Set CLI To: Customer's default

Centrex Number: [Field]

Hide CLI: Customer's default

Hide CLI Prefix: [Field]

Show CLI Prefix: [Field]

Voice VPN Distinctive Ring: Customer's default

E911: No

Associated Number: [Field]

Music On Hold: Customer's default

Legal Intercept: Customer's default

Preferred IVR Language: en - English

UM Enabled:  ←

Forward Mode: No Forwarding

Maximum Forwards: [Field]

Timeout, sec: 30

Default Answering Mode: Ring, forward, voic

Call Processing Enabled:

Favorite Numbers Enabled: Customer's default

4. Click on the **Service Features** tab.
5. Click on the **UM Enabled** checkbox to activate UM services for this account.
6. Click **Save&Close**.

## Setting Up and Using Prepaid IVR on PortaUM

Sometimes an incoming call for a prepaid card service will arrive to your network via IP. For instance, say you bought an access number in a

country where you do not own any network infrastructure; so instead of using E1 or T1 lines, a telco in that country will forward calls to you using SIP. In this case using a Cisco GW may be cumbersome, since you first have to convert the IP call to PSTN and then send it back via IP. Instead, you can run the built-in prepaid application on PortaUM which, combined with a PSTN access number delivered directly to PortaSIP via IP, allows you to offer a purely IP-based solution for prepaid calling card services.

This chapter assumes that you have already set up UM services as per the previous section, and have verified that they are working.

## Configure Prepaid Application

First you need to configure general parameters for the prepaid application in **porta-um.conf**. These include, for instance, the special DNIS that the IVR runs on, the virtual PortaBilling environment where this application is used, languages, and prepaid card length. For a complete overview of the available options, please also consult the inline documentation at **porta-um.conf**.

### Set up DNIS number

Set up the DNIS number for the virtual PortaBilling environment where you want to use this application. This uses the following format:

```
Ext<N>=<i_env>:<extension>:<ANI translation rule>
```

where N is a unique arbitrary number. For instance, if the ID of your environment is 1 and the DNIS will be 111222333, you should enter:

```
Ext1=1:111222333:
```

The option of configuring an ANI translation rule for this application will only be available if the parameter `AniAuth` is set to 'yes'.

Of course, you can have multiple entries in order to register the prepaid application on more than one internal DNIS mailbox. This allows you to run the application in multiple environments, on multiple access numbers, and/or with potentially different languages or ANI translation rules, according to your requirements. Just register these additional extensions as "Ext2", "Ext3", and so on.

### Configure languages

Configure which languages should be used for the IVR prompts. This option uses the following format:

Languages<N>=<i\_env>:dnis\_number:<lang\_1>/<lang\_2>/<lang\_3>

where N is a unique arbitrary number. For instance, if the ID of your virtual PortaBilling environment is 1, the DNIS is 111222333, and you would like to use Spanish voice prompts, you should enter:

Languages1=1:111222333:es:

where N is a unique arbitrary number. You can also configure more than one language for the same DNIS, as follows:

Languages1=1:111222333:en/ru:

In this case, the IVR’s first prompt will be the language selection prompt “Please select 1 for English, 2 for Russian”.

**Note:** Language IVR files (audio files) must first be uploaded before they can be used in any IVR applications. At the moment, only English prompts are provided by PortaOne, with instructions for adding other languages available upon request.

### Configure additional options

Optionally, you can configure any of the following additional parameters.

Parameter	Description
MaxCardLen	Maximum length of card number; default: 11.
MinCardLen	Minimum length of card number; default: 11.
AniAuth	Is ANI authentication enabled? Default: no.
ManualAuth	Is manual authentication enabled? Default: yes.
MaxLoginAttempts	Maximum number of attempts to enter a card number; default: 3.
MaxDialAttempts	Maximum number of dial attempts within one session; default: 3.
TollFreeAllowed	If this parameter is set to ‘false’, the prepaid application will exit immediately if the account has insufficient funds. Default: false.

### Configure PSTN access

Once you have configured the prepaid application on PortaUM, you need to give your customers access to it via PSTN. Of course, the DNIS\_number that was configured in the first step can already be called from any SIP phone on your network. However, the purpose of this prepaid application will most likely be to give customers access to your network via a PSTN access number.

1. Please follow the instructions in our “PortaSIP Handbook: SIP Services”, specifically section 2, entitled “Setting Up PSTN-to-SIP Services”.
2. Enable UM for the PSTN access number account. As with any PSTN-to-SIP service, the account will have an account number identical to your PSTN access number or the DID forwarded by your vendor to PortaSIP. You must enable UM for this account to associate it with the internal “DNIS\_mailbox” on the PortaUM you have already configured.

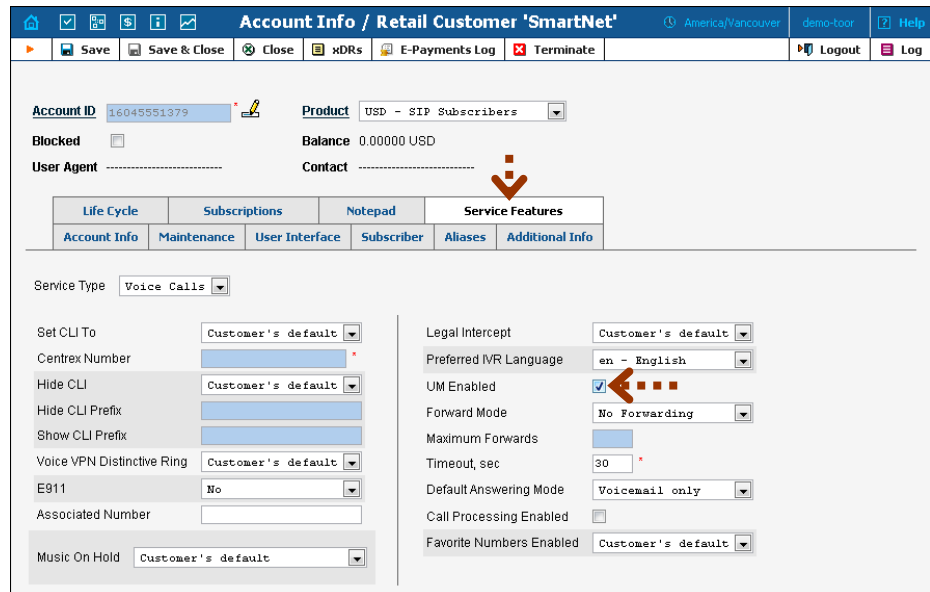

The screenshot displays the 'Account Info / Retail Customer 'SmartNet'' interface. The 'Service Features' tab is selected, showing the 'UM Enabled' checkbox checked. A red arrow points to this checkbox. Other visible settings include 'Service Type' set to 'Voice Calls', 'Preferred IVR Language' set to 'en - English', and 'Default Answering Mode' set to 'Voicemail only'.

Since no SIP UA has been registered to this account, the call will go directly to PortaUM.

### Restart UM services

Restart UM services so that the changes to `porta-um.conf` will take effect. To stop or start UM services, use the following commands:

```
sudo /usr/local/etc/rc.d/voice-mail.sh stop
sudo /usr/local/etc/rc.d/voice-mail.sh start
```

## PortaBilling Configuration for Prepaid Card Service

You should perform the billing configuration according to the instructions in [PortaBilling100 Handbook: Prepaid Services](#), the only exception being that you will use your PortaUM node instead of a gateway.

## Using ANI Authentication for PIN-less Dialing

In order to support PIN-less dialing, the prepaid application can be configured with the parameter `AniAuth` set to 'yes'. If an incoming call matches one of your accounts by ANI, the customer will immediately be asked to enter a call destination, skipping the PIN number entry step.

### Using an external ANI for authorization only

You may wish to allow customers to use their account not just by dialing from their registered SIP account (regular ANI authentication) but also from any other kinds of phones (cell phone, regular home phone). In order to successfully authenticate these ANIs, you need to create them as regular accounts under your customers.

However, to prevent PortaBilling from trying to terminate actual calls to these "ANI only" accounts, it is recommended that you adopt a naming convention that allows you to easily distinguish these accounts from your regular SIP accounts and to keep PortaBilling from routing to these accounts.

One suggested naming convention that does all of this is using the prefix 'ani' for your ANI authentication accounts (naturally, you can choose a different prefix as well). For instance, if you would like to allow your customer to use his cell phone with ANI 1604112222 for ANI authentication, you would create the account `ani1604112222` under this customer.

### Set up ANI translation rule

If you have adopted a naming convention for external numbers which are to be authenticated by ANI, you need to set up an ANI translation rule in order to successfully authenticate these accounts.

Assuming that the prefix you have chosen is 'ani', you will need to change your prepaid application configuration from:

```
Ext1=1:111222333:
```

to:

```
Ext1=1:111222333:s/^/ani/;
```

The prepaid application will use the incoming ANI, prefixing it with 'ani' and then trying to look up that account in the database.

## Using UM Services

PortaUM allows Internet Telephony Service Providers (ITSPs) to offer their subscribers the ability to process emails and manage voicemail from within a web browser or using a favorite email client.

The PortaUM End-User Manual is available from the PortaOne website: [www.portaone.com/support/documentation/](http://www.portaone.com/support/documentation/)

PortaUM users can also access their mailbox via a telephony interface, which allows them to listen to voice messages. UM options for accessing the mailbox can also be configured by phone.

## IVR Path Diagram

The PortaUM mailbox can be accessed by phone by dialing \*98. Below is an IVR path diagram to help users in navigating and configuring the system.

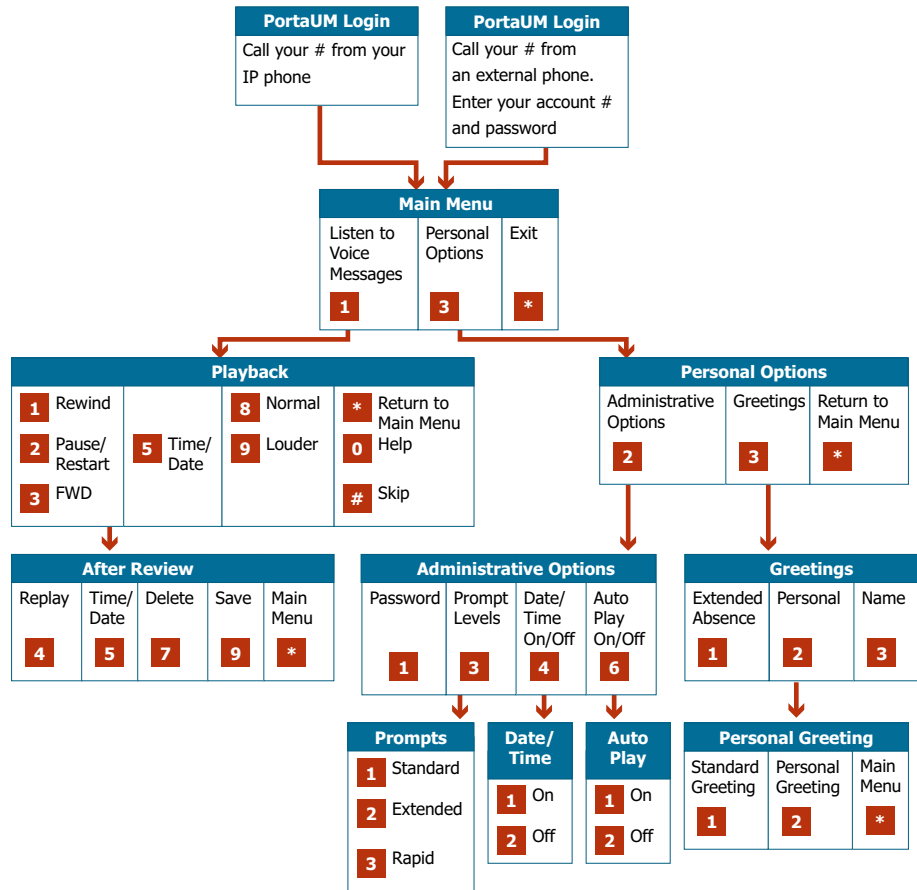

# 3. PortaBridge

## PortaBridge Architecture

As part of the PortaUM solution, PortaBridge enables your customers to use voice-conferencing services. Multiple customers can use this service simultaneously on a single PortaBridge server. A customer account with this service enabled has access to the PortaBridge self-care interface, where multiple conferences can be managed. A conference can be scheduled for a specific time, or a continually functioning conference (meeting room) can be created. Each conference is identified by a pair of unique access codes (one for the conference host, the other for conference guests). Although multiple conferences can be created on a PortaBridge server, its resources are only used when a conference is in progress (i.e. at least one participant is in).

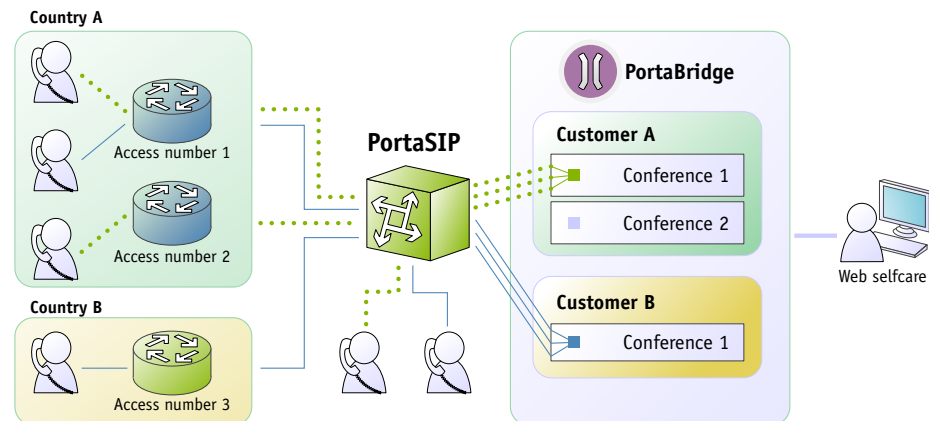

When a customer makes use of the conferencing facility, the PortaBilling administrator assigns a separate tariff for the conferencing service in the customer's product configuration, and the owner of the meeting room is then billed for each incoming call in a conference session. For example, if your conference rate is \$0.03/min, and a customer organizes a conference for two participants where he (the host) stays connected for 30 minutes and his two partners stay connected for 25 and 20 minutes, respectively, then there will be three charge transactions in total: \$0.90, \$0.75 and \$0.60. To prevent potential service abuse by guests, customers may create a moderated conference. In this case, guests can only participate in a conference when the host has already joined it.

PortaBridge carries out intensive calculations when mixing the audio from several meeting participants, and so requires significant amounts of CPU power. This is why it should be installed on a dedicated server.

## PortaBridge and Codec Licenses

Normally, a media server (such as the one used in PortaUM) will send pre-converted voice prompts to the user as a byte stream, so that no codec licenses are involved. In the case of PortaBridge, however, the audio-stream with the voice of each participant has to be decoded in real time, and then sent back to each participant as an encoded audio-stream with the mixed sound. Thus, if commercial codecs (such as g729) are used, a codec license is required for each voice channel being used simultaneously. The PortaBridge license **does not include any codec licenses**, and customers should procure such licenses independently.

# 4 . Setting Up and Using Conferencing Services

# Setting Up Conferencing Services in PortaBridge

Please refer to the [PortaBilling100 Web Reference Guide](#) for detailed instructions on how to navigate and operate the web interface, as well as detailed explanations of particular fields.

## Checklist

Print the following page and use it to check off the operations you have completed while performing system setup according to the instructions in this chapter. Please be sure to perform all of the operations (all of the boxes must be checked), otherwise the service will not work.

Operation	Done
<b>General configuration</b>	
General configuration has already been done according to the instructions in previous chapters.	[ <input type="checkbox"/> ]
<b>Network configuration</b>	
Create a node for your PortaBridge server.	[ <input type="checkbox"/> ]
<b>Rating configuration</b>	
Create tariff A, which will apply to conferencing services used by your customers (make sure this tariff has the <b>Conferencing</b> service assigned!).	[ <input type="checkbox"/> ]
Enter rates in tariff A for access numbers used for the conferencing service.	[ <input type="checkbox"/> ]
Create a new accessibility entry in your existing product A, using the conferencing service, PortaBridge node and tariff A.	[ <input type="checkbox"/> ]
Create tariff B, which will define call routing to PortaBridge (make sure this tariff has the <b>Routing</b> type and the <b>Voice Calls</b> service assigned!).	[ <input type="checkbox"/> ]
Enter rates in tariff B for access numbers used for the conferencing service.	[ <input type="checkbox"/> ]
Create a connection for your “internal” vendor (the one created in the basic SIP service configuration for handling SIP on-net calls) using tariff B.	[ <input type="checkbox"/> ]
Create tariff C (vendor tariff for the conferencing service), which will be used to keep track of your PortaBridge use.	[ <input type="checkbox"/> ]
Enter rates in tariff C for access numbers used for the conferencing service.	[ <input type="checkbox"/> ]
Create a connection for your “internal” vendor using tariff C.	[ <input type="checkbox"/> ]
Specify rates for dialing into the conferencing bridge for your “normal” SIP accounts.	[ <input type="checkbox"/> ]
<b>Account provisioning</b>	
Enable the conferencing service for an existing account (with product A).	[ <input type="checkbox"/> ]
<b>Testing</b>	
Log in to the PortaBridge self-care interface as an account owner and create a new conference.	[ <input type="checkbox"/> ]
Dial the conference access number from an IP phone and log in into the conference.	[ <input type="checkbox"/> ]

## General Configuration

This is identical to the procedure described in the *Prepaid VoIP services* chapter in the [PortaSIP Handbook: SIP Services](#). Please follow the instructions provided there.

## Create a PortaBridge Node

You now need to enter your PortaBridge server as a node. PortaBilling requires some key information about your network equipment, such as the IP address, h323-id, Radius shared secret, and so on.

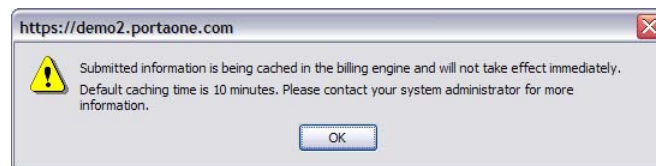
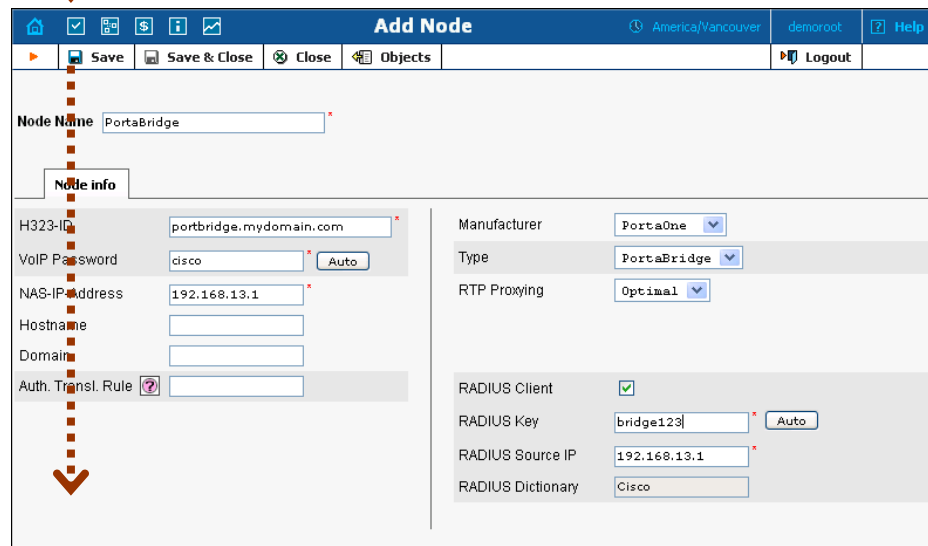
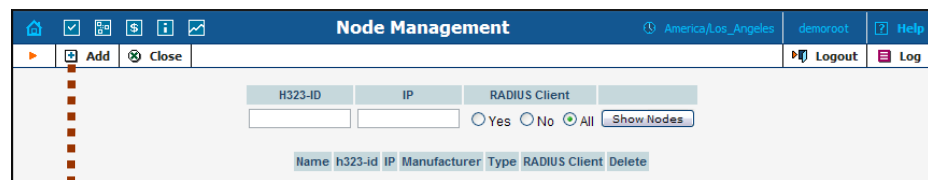

1. In the Management section of the Admin-Index page, choose **Nodes**.
2. In the Node Management window, click the  **Add** icon.
3. Fill in the New Node form:
  - o **Node Name** – A short descriptive name for your PortaBridge server (this will be used in the select menus).



- **H323-ID** – PortaBridge server’s hostname (recommended: `hostname.domainname`).
  - **VoIP Password** – Enter `cisco` here for backward compatibility with other types of equipment.
  - **NAS-IP-Address** – The IP address of the PortaBridge server.
  - **Domain** – Enter the PortaBridge server’s hostname, i.e. the same value you specified during server installation, e.g. `conf.mydomain.com`. This parameter is very important, since without it authentication requests from PortaBridge cannot be processed correctly.
  - **Auth. Translation Rule** – Leave this blank.
  - **Manufacturer** – Select **PortaOne**.
  - **Type** – VoIP node type; select **PortaBridge**.
  - **Radius Client** – Check this, as PortaBridge will need to communicate with billing.
  - **Radius Key** – Enter the Radius shared secret here; this must be the same key which you entered during PortaBridge installation.
  - **Radius Source IP** – See the **Node ID, NAS IP Address and Radius Source IP** section in the [PortaBilling Administrator Guide](#) for more information. Unless your PortaBridge server uses multiple network interfaces, the value here should be the same as the NAS-IP-Address.
4. Click  **Save&Close**.

**NOTE:** There is some propagation delay between the database and the Radius server configuration file; however, it will take no longer than 15 minutes.

## Create a Conferencing Charge Tariff

This tariff will be used to charge your customers who own a conference (meeting room) for every incoming call to that conference.

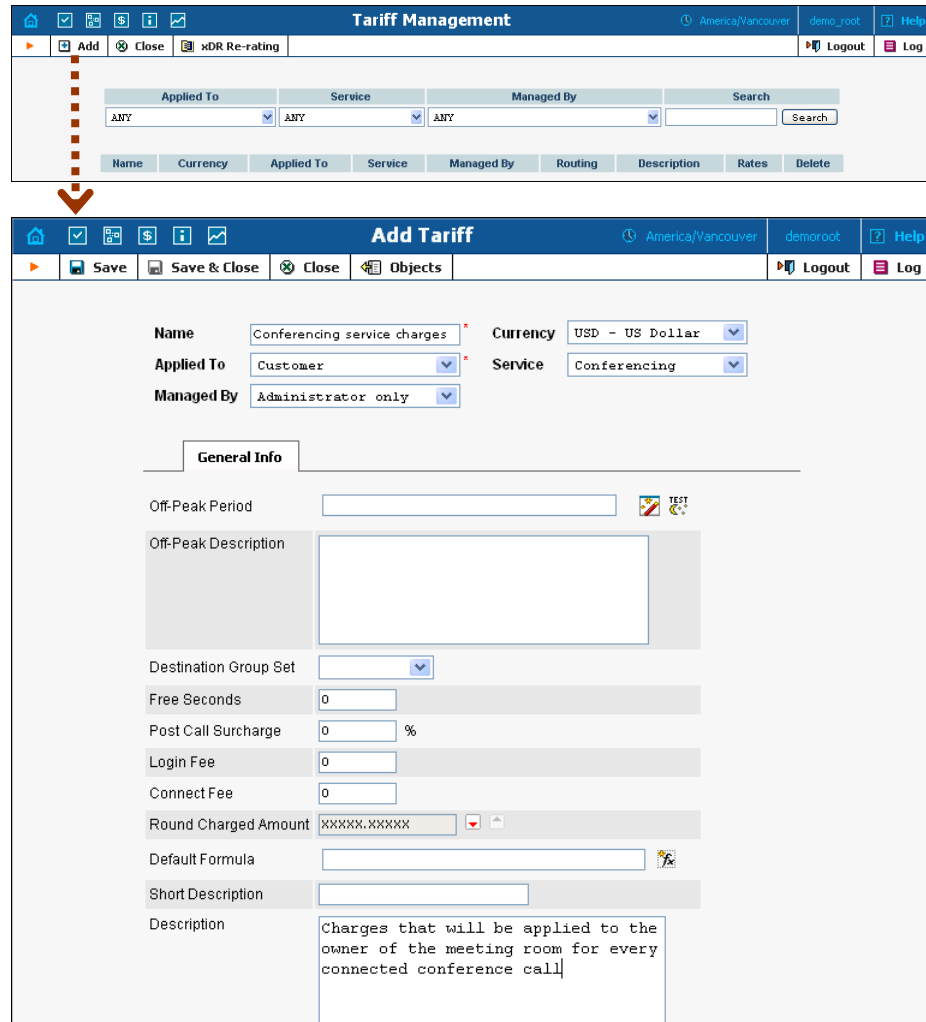

The image shows two screenshots of a web application interface. The top screenshot is the 'Tariff Management' page, which has a table with columns: Name, Currency, Applied To, Service, Managed By, Routing, Description, Rates, and Delete. A red dashed arrow points from the 'Add' button in the top navigation bar to the 'Add Tariff' form below. The bottom screenshot is the 'Add Tariff' form, which includes the following fields:

- Name:** Conferencing service charges
- Currency:** USD - US Dollar
- Applied To:** Customer
- Service:** Conferencing
- Managed By:** Administrator only

The form also includes a 'General Info' section with the following fields:

- Off-Peak Period:** (empty text box)
- Off-Peak Description:** (empty text area)
- Destination Group Set:** (dropdown menu)
- Free Seconds:** 0
- Post Call Surcharge:** 0 %
- Login Fee:** 0
- Connect Fee:** 0
- Round Charged Amount:** xxxxxx.xxxxxx
- Default Formula:** (empty text box)
- Short Description:** (empty text box)
- Description:** Charges that will be applied to the owner of the meeting room for every connected conference call

1. In the Management section of the Admin-Index page, choose **Tariffs**.
2. On the Tariff Management page, choose **Add**.
3. Fill in the **Add Tariff** form:
  - o **Name** – A short name for the tariff object (this will be used in the select menus).
  - o **Currency** – Indicates in which currency pricing information is given. All pricing information for a single tariff must be defined in the same currency.

**NOTE:** If you plan to bundle the conferencing service with some existing product, this tariff must have the same currency as that product.

- **Applied To** – Choose the **Customer** in the **Applied To** field.
  - **Managed By** – Choose **Administrator only** here (this option is only visible after you select **Applied To Customer** above).
  - **Service** – Choose **Conferencing** here.
  - The rest of the fields are identical to the tariff configuration for SIP services you performed earlier.
4. Click  **Save**.

## Enter Rates



Enter the rates you will charge your customers for conferencing service use. You may charge them a different rate based on access number, e.g. if someone calls a US local access number, the rate is \$0.03/min, while it is \$0.04/min to use a local access number in the UK, and \$0.06/min to use a US toll-free access number.

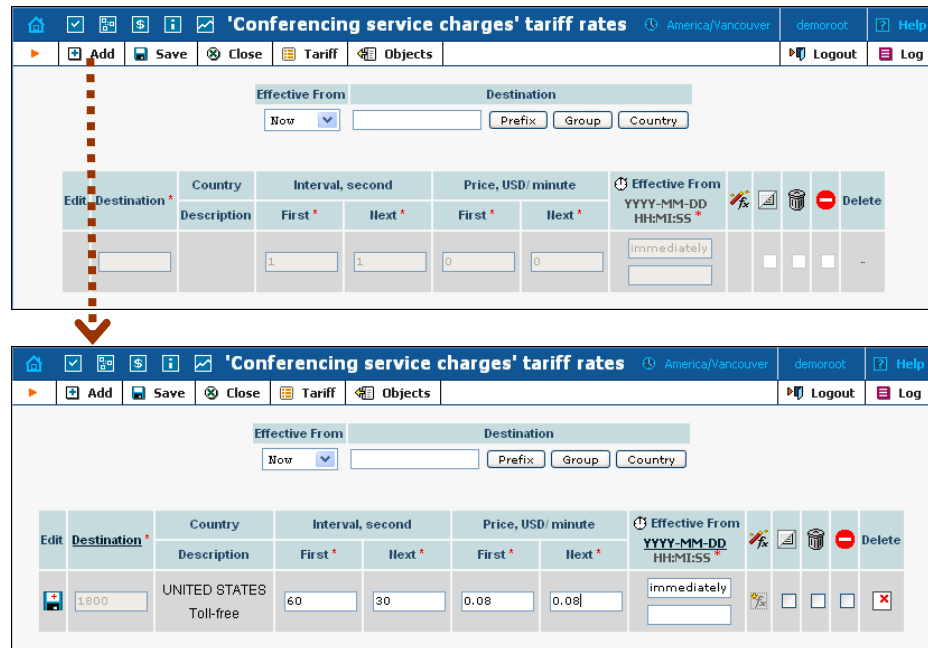

## Managing rates online

This is very convenient for maintaining existing rate tables and for reference purposes. For new price lists or major updates, the offline method is better.



The screenshots show the 'Conferencing service charges' tariff rates configuration page. The top screenshot shows the 'Add' button highlighted with a red dashed arrow. The bottom screenshot shows the 'Add' button highlighted with a red solid arrow, and a table with one row of data.

Edit	Destination *	Country	Interval, second		Price, USD/minute		Effective From YYYY-MM-DD HH:MI:SS *	Delete
			First *	Next *	First *	Next *		
	1800	UNITED STATES Toll-free	60	30	0.08	0.08	immediately	

7. On the Tariff Management page you will see a list of the available tariffs. Click the  **Rates** icon next to the name of the tariff. When you are in Tariff Management for a particular tariff, click on **Rates** in the toolbar.
8. On the **Edit Rates** screen, click  **Add**.
9. Fill in the required information:

- **Destination** – A destination prefix may be entered directly, e.g. **55** for Brazil, or you can access the destinations directory by clicking the **Destination** link (in the column header). Here you can find the desired prefix by country name.



**NOTE:** The phone prefix you are trying to create a rate for must already exist in Destinations.

- **Interval First** – First billing unit in seconds.
- **Interval Next** – Next billing unit in seconds.
- **Price First** – Per-minute price for first interval.
- **Price Next** – Per-minute price for next interval.
- **Off-peak Interval First** – First billing unit in seconds for off-peak time.
- **Off-peak Interval Next** – Next billing unit in seconds for off-peak time.
- **Off-peak Price First** – Per-minute price for first interval of off-peak time.
- **Off-peak Price Next** – Per-minute price for next interval of off-peak time.

**NOTE:** Off-peak fields appear only if an **off-peak period** has been defined for the tariff.

- **Rate Formula Wizard**  – Launches the wizard for creating a custom rating formula.
- **Effective From** – If you want this rate to take effect sometime in the future, you can either type in the date manually, or use the calendar (click on **DD-MM-YYYY**).



**NOTE:** When using the calendar, you can specify that the date you are entering is in a different time zone than your present one. PortaBilling will then automatically adjust the time.

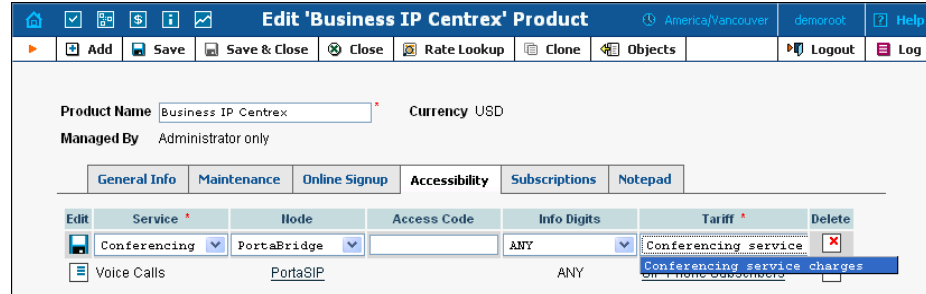

- The **Hidden**, **Forbidden** or **Discontinued** flags are optional.
10. Click the  **Save** button in the toolbar, or the  icon on the left side of the row.
  11. Repeat these steps if you need to enter more rates.

## Add the Conferencing Service to Your Product

The Accessibility list has two functions: it defines permitted access points (nodes and access numbers) and specifies which tariff should be used for billing in each of these points.



Edit	Service *	Node	Access Code	Info Digits	Tariff *	Delete
	Conferencing	PortaBridge		ANY	Conferencing service charges	

1. On the Product Management page, click the product name to enter the **Edit Product** form.
2. When the Accessibility tab is selected, click on the  **Add** icon.
3. Choose **Conferencing** in the **Service** select menu.
4. Select the PortaBridge node and choose the conferencing tariff you created earlier.
5. The **Access Code** should be left empty for the conferencing service.
6. The **Info Digits** field is not applicable to the conferencing service; just leave it empty.
7. Click  **Save** to save this accessibility entry.

## Create a Call Routing Tariff and Add Rates

When a conference bridge is dialed from an IP phone, or an access number from the PSTN, and the call arrives to your network, PortaSwitch must recognize that it is to be forwarded to PortaBridge. In order to do this properly, PortaSwitch must be able to determine the routing in the same way as it does for any other call in the system. Therefore, there needs to be a routing tariff with a destination matching the dialed number. Later on, this tariff should also be assigned to a connection.

Create the tariff and define rates for it in the way described in the [PortaSIP Handbook: SIP Services](#).

## Define an On-net Vendor Connection

Use the same vendor you previously created for the accounting of on-net calls (calls between your SIP phones).

1. In the Management section of the admin interface, choose **Vendors**.
2. Click on the **Connections** icon next to the on-net vendor name.

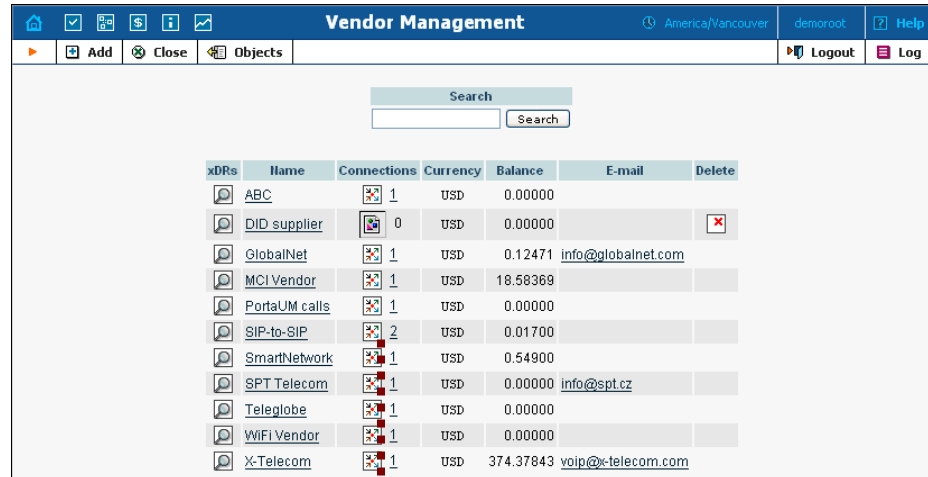

**Vendor Management** | America/Vancouver | demoroot | Help

Search:  Search

xDRs	Name	Connections	Currency	Balance	E-mail	Delete
	ABC	1	USD	0.00000		
	DID supplier	0	USD	0.00000		
	GlobalNet	1	USD	0.12471	info@globalnet.com	
	MCI Vendor	1	USD	18.58369		
	PortaUM calls	1	USD	0.00000		
	SIP-to-SIP	2	USD	0.01700		
	SmartNetwork	1	USD	0.54900		
	SPT Telecom	1	USD	0.00000	info@spt.cz	
	Teleglobe	1	USD	0.00000		
	WiFi Vendor	1	USD	0.00000		
	X-Telecom	1	USD	374.37843	voip@x-telecom.com	

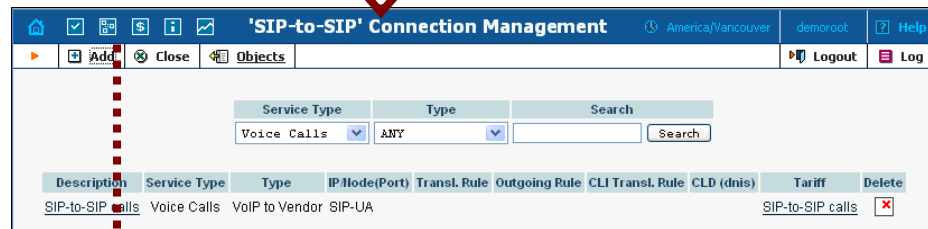

**'SIP-to-SIP' Connection Management** | America/Vancouver | demoroot | Help

Service Type: Voice Calls | Type: ANY | Search:  Search

Description	Service Type	Type	IP Node (Port)	Transl. Rule	Outgoing Rule	CLI Transl. Rule	CLD (dnis)	Tariff	Delete
SIP-to-SIP calls	Voice Calls	VoIP to Vendor	SIP-UA					SIP-to-SIP calls	

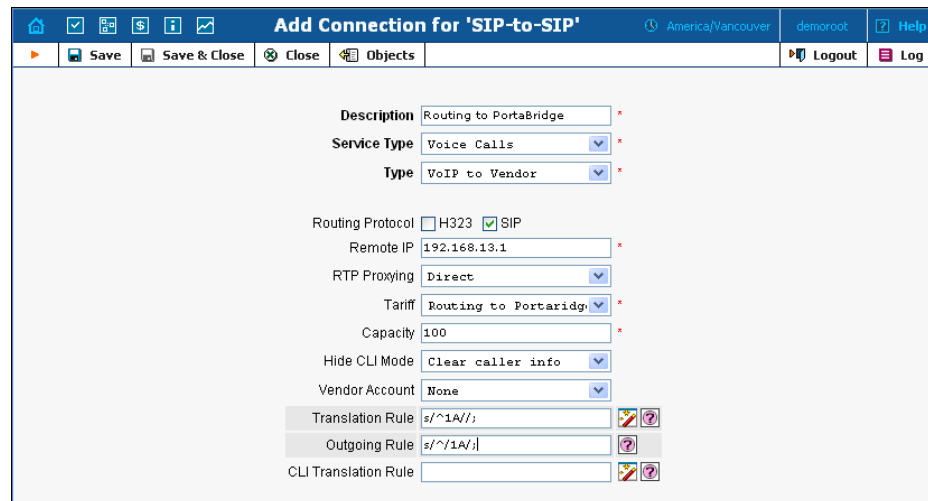

**Add Connection for 'SIP-to-SIP'** | America/Vancouver | demoroot | Help

Save | Save & Close | Close | Objects | Logout | Log

Description: Routing to PortaBridge \*

Service Type: Voice Calls \*

Type: VoIP to Vendor \*

Routing Protocol:  H323  SIP

Remote IP: 192.168.13.1 \*

RTP Proxying: Direct

Tariff: Routing to Portaridge \*

Capacity: 100 \*

Hide CLI Mode: Clear caller info

Vendor Account: None

Translation Rule: s/^1A//

Outgoing Rule: s/^1A/

CLI Translation Rule:

3. Click **Add** to add a new connection.
4. Fill in the connection information:

- Enter your PortaBridge IP address in the **Remote IP** field.
  - Choose the routing tariff you created under **Tariff**.
  - Enter the translation rule `s/^1A//;` as the **Translation Rule**.
  - Enter the translation rule `s//1A/;` as the **Outgoing Rule**.
5. Click  **Save&Close**.

## Create a Conferencing Cost Tariff

This tariff will be used to produce CDRs for calls processed by PortaBridge, in order to provide better tracking and reporting. Create this tariff with **Conferencing** assigned as a **Service**, and make sure you select **Vendor** in the **Applied To** select menu. Follow the previous instructions for filling in the rest of the fields.

## Add Rates to Conferencing Cost Tariff



Enter rates for the numbers that your customers will dial to access conferences.

## Define an “Internal” Vendor Conferencing Connection

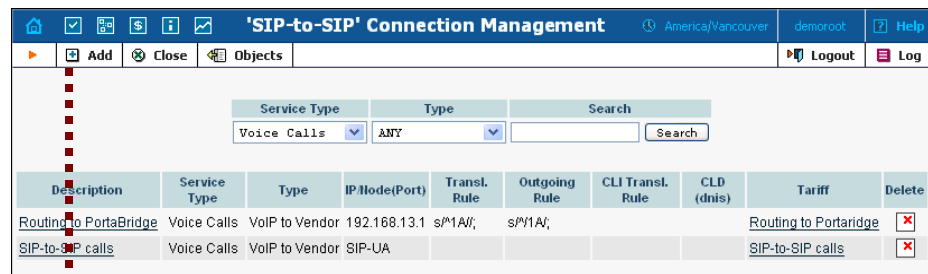
1. In the Management section of the admin interface, choose **Vendors**.
2. Click on the **Connections** icon next to the name of the “internal” vendor you used in the previous steps.



The screenshot shows the 'SIP-to-SIP' Connection Management interface. At the top, there are navigation icons and a search bar. Below the search bar is a table with columns: Description, Service Type, Type, IP/Node/Port, Transl. Rule, Outgoing Rule, CLI Transl. Rule, CLD (dnis), Tariff, and Delete. Two rows are visible in the table:

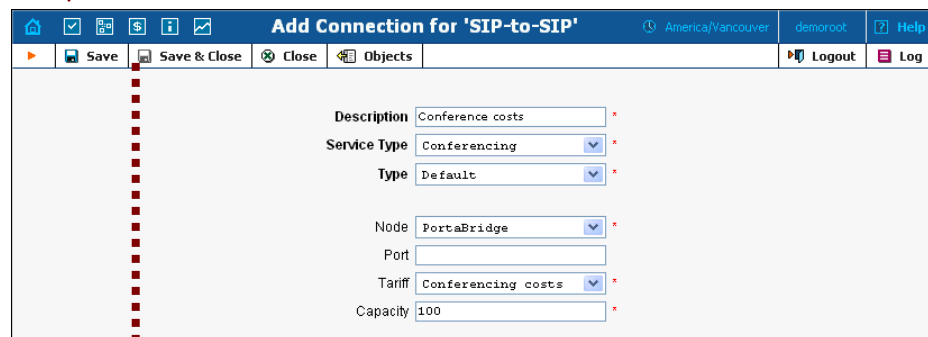

Description	Service Type	Type	IP/Node/Port	Transl. Rule	Outgoing Rule	CLI Transl. Rule	CLD (dnis)	Tariff	Delete
Routing to PortaBridge	Voice Calls	VoIP to Vendor	192.168.13.1	s^1A/;	s^1A/;			Routing to Portaridge	
SIP-to-SIP calls	Voice Calls	VoIP to Vendor	SIP-UA					SIP-to-SIP calls	

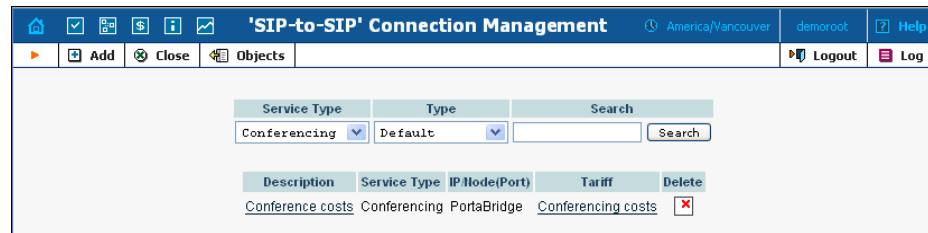

The screenshot shows the 'Add Connection for SIP-to-SIP' form. It contains several fields with dropdown menus and text inputs:

- Description:** Conference costs \*
- Service Type:** Conferencing \*
- Type:** Default \*
- Node:** PortaBridge \*
- Port:** (empty field)
- Tariff:** Conferencing costs \*
- Capacity:** 100 \*



3. Click  **Add** to add a new connection.
4. Fill in the connection information.
  - Choose **Conferencing** as the **Service Type**.
  - Select your PortaBridge as the node.
  - In the **Tariff** select menu, choose the conferencing cost tariff you created in the previous steps.
  - Leave the **Port** field empty.
  - **Description** and **Capacity** are mandatory for all connection types, so please provide the appropriate values.
5. Click  **Save&Close**.

## Add Rates to the SIP Call Tariff

In the previous step you defined routing in the system. However, in order for customers to be able to call the conference access number from their IP phones, their tariff plan needs to allow this.

Please define the rates for the conference access number in the way described in the [PortaSIP Handbook: SIP Services](#).

## Configure DID for External Conference Access Numbers

This is done in a similar way to the DID service configuration described in the [PortaSIP Handbook: SIP Services](#).

## Enable the Conferencing Service for an Account

1. Go to the **Customers** screen (the screen containing a list of customers). It should look like the screenshot below.
2. Next to the customer's name, click on the  icon (in the **Accounts** column). This will take you to account management for that customer.
3. Type an ID in the **Account ID** field and click **Show Accounts**, so that the **Account Info** screen appears. (If you see a list with several accounts, click on the account ID link of the one you wish to edit).

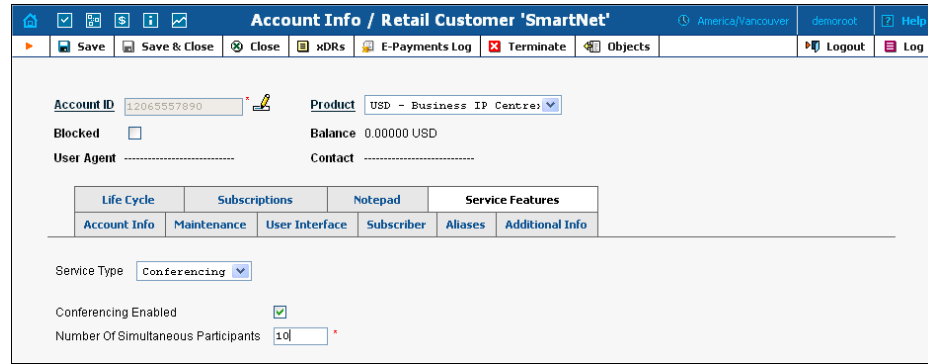

4. Select the **Service Features** tab, then choose the **Conferencing** service from the menu.
5. Tick the **Conferencing Enabled** checkbox and enter the maximum allowed number of participants in the field below.
6. Click **Save&Close** to save the account information.
7. Repeat steps 3-6 if you wish to enable the conferencing service for any other accounts.

## Scheduling a Conference

### Log in to the PortaBridge self-care interface

1. Open <http://<your-porta-bridge-address>> in your browser (inserting the actual hostname or IP of your PortaBridge server).
2. Use the ID of your account with the conferencing service enabled as **Name**, and the **User Interface Password** as **Password**. After successfully logging in, the main menu of the PortaBridge self-care interface will appear.

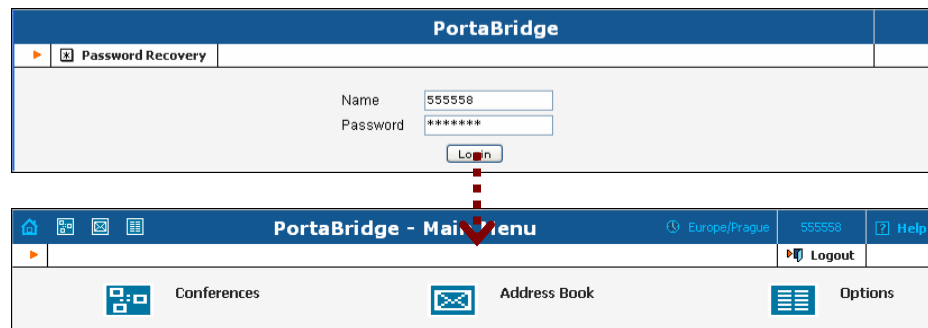

### Create a conference

1. Click on the Conferences item in the main menu.

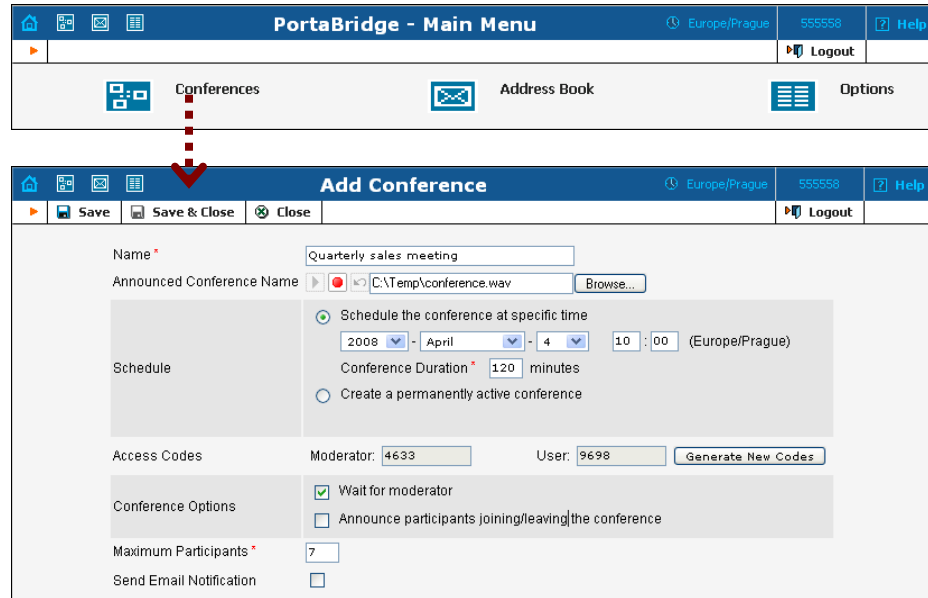

2. Fill in the **Add Conference** form; see the following table for a description of the available fields

Field	Description
<b>Name</b>	A description of your conference.
<b>Announced Conference Name</b>	Either upload a sound file, or record (using your PC's microphone) the name of the conference as it will be announced to people joining it.
<b>Schedule</b>	Specify the date and time when the conference will start.
<b>Access Codes</b>	Access codes are created automatically, but you can generate a new set of codes by clicking on the <b>Generate New Codes</b> button.
<b>Conference Duration</b>	In order to prevent service abuse, you must specify the maximum allowed conference duration (in minutes).
<b>Maximum Session Time</b>	If you are creating a "meeting room" (a permanently active conference), specify the maximum time that a single participant can stay in the conference. This is also done to prevent potential service abuse.
<b>Conference Options: Wait for moderator</b>	If activated, conference participants will not be able to communicate with each other until the host (moderator) arrives.
<b>Conference Options: Announce participants</b>	If activated, each participant will be asked to record his or her name initially. When he or she enters the conference, all the other participants will hear "... has joined the conference"; and when he or she leaves, the other participants will be informed of

	this as well.
<b>Maximum Participants</b>	You can limit the maximum allowed number of concurrent connections to the meeting room. Note that you may not specify a higher value here than the <b>Number of Simultaneous Participants</b> assigned by the PortaBilling administrator to your account (in the <b>Service Features</b> tab on your account info).
<b>Send Email Notification</b>	If selected, another screen will appear after you save the conference, allowing you to review and send yourself or other hosts an email containing conference access information.

3. Click  **Save&Close** to save the conference.

### Send a note with the conference info

If you have chosen **Send Email Notification** on the **Add Conference** screen, you will now see the **Email Notification** screen. Edit the email text, if desired, and select who is to receive it (you can either type in the addresses or select them from your address book).

Click the  **Send** button to send the message.

## Testing a Conference

1. Dial the conference access number from a phone and enter your access code. Do the same from the other phones for other participants.
2. When the conference is over, you can review the charges for the conferencing service on the PortaBilling web interface:

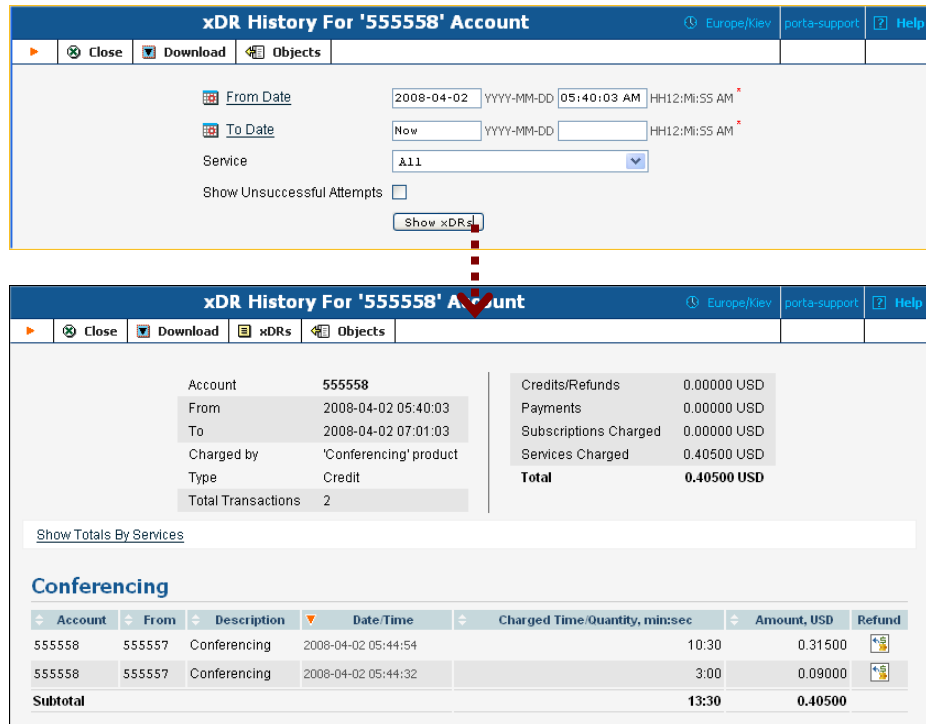

**xDR History For '55558' Account**

From Date: 2008-04-02 05:40:03 AM  
 To Date: Now  
 Service: All  
 Show Unsuccessful Attempts:   
 Show xDRs

---

**xDR History For '55558' Account**

Account: 55558  
 From: 2008-04-02 05:40:03  
 To: 2008-04-02 07:01:03  
 Charged by: 'Conferencing' product  
 Type: Credit  
 Total Transactions: 2

Credits/Refunds: 0.00000 USD  
 Payments: 0.00000 USD  
 Subscriptions Charged: 0.00000 USD  
 Services Charged: 0.40500 USD  
**Total: 0.40500 USD**

Show Totals By Services

**Conferencing**

Account	From	Description	Date/Time	Charged Time/Quantity, min:sec	Amount, USD	Refund
555558	555557	Conferencing	2008-04-02 05:44:54	10:30	0.31500	
555558	555557	Conferencing	2008-04-02 05:44:32	3:00	0.09000	
<b>Subtotal</b>				<b>13:30</b>	<b>0.40500</b>	

# 5. Administration

## PortaUM Configuration

PortaUM provides a unified configuration tool. Even if a system consists of several components, using different technologies and configuration methods, you need only edit one simple configuration file. This master configuration file is then used by PortaOne configuration scripts to manage and provision other modules, e.g. IMAP, MWI, IVR applications, and so on.

### porta-um.conf

This is the only file you need to edit in order to modify PortaUM parameters. Every row starting with a # is considered to be a comment; other lines will contain VAR=VALUE pairs, separated by an equal sign (=). This file is created automatically during installation. Thus, assuming you provided the correct parameters during installation, you will not have to change anything. However, you might want to examine certain defaults and change them to values more appropriate to your business.

**Note:** As always, if you are not certain what the various parameters mean and what they do, please contact our support team first for clarification, and let them assist you in making the appropriate changes.

Variable	Description
<b>Global</b>	
<b>DefaultPassword</b>	The default voicemail password for new accounts. Initially 777, but can later be changed by customers on their self-care interface.
<b>DefaultOffset</b>	15
<b>TmpDir</b>	PortaUM system temp directory; default: /var/tmp
<b>AttachDir</b>	PortaUM system upload directory; default: /var/tmp/upload
<b>FilePath</b>	/home/porta-um/apache
<b>PasswdRecoveryURL</b>	https://193.28.87.35:8445/forgot.html
<b>DefaultAlwaysPassword</b>	Default: no.
<b>IMAP</b>	
<b>NewuserQuota</b>	Maximum allowed size of mailbox; assigned to all mailboxes when they are created.
<b>Web</b>	
<b>BrandPane</b>	The BrandPane option places the contents of a given file at the top of the

	PortaUM web interface. If, for example, you choose “BrandPane=/brandpane.html”, then this file must be placed under the web server document root (e.g. /home/porta-um/SquirrelMail/brandpane.html).
<b>JavaPolicyInstallerURL</b>	http://www.portaone.com/resources/PortaUM_Client_1.0.exe
<b>RechargeVoucher</b>	
<b>MaxVoucherLen</b>	Maximum length of voucher number; default: 11.
<b>MinVoucherLen</b>	Minimum length of voucher number; default: 11.
<b>DebitCard</b>	
<b>MaxCardLen</b>	Maximum length of card number; default: 11.
<b>MinCardLen</b>	Minimum length of card number; default: 11.
<b>AniAuth</b>	Is ANI authentication enabled? Default: no.
<b>ManualAuth</b>	Is manual authentication enabled? Default: yes.
<b>MaxLoginAttempts</b>	Maximum number of attempts to enter a card number; default: 3.
<b>MaxDialAttempts</b>	Maximum number of dial attempts within one session; default: 3.
<b>TollFreeAllowed</b>	If this parameter is set to ‘false’, then the Debit Card application will exit immediately if the account has insufficient funds. Default: false.
<b>Ext&lt;N&gt;</b>	<p>Description of extensions used for the prepaid card application. These can contain several lines in the following format:</p> <pre>Ext&lt;N&gt;=&lt;i_env&gt;:&lt;extension&gt;:&lt;ANI translation rule&gt;</pre> <p>Where:</p> <ul style="list-style-type: none"> <li>N - arbitrary unique number</li> <li>i_env - ID of the environment</li> <li>extension - extension for the prepaid card application</li> <li>ANI translation rule – a regular expression (used only if AniAuth=yes)</li> </ul> <p>Example:</p> <pre>Ext1=1:1234567891:s/^8.*(. )\$/8888888888\$1/;</pre>
<b>Voicemail</b>	

<b>MinServers</b>	200	Daemon options for Cisco-less setup
<b>MaxServers</b>	300	
<b>MinSpareServers</b>	20	
<b>MaxSpareServers</b>	30	
<b>MinDuration</b>	Minimum length of voice message, in seconds. If the voice message is shorter or equal to the MinDuration value, the message will be canceled. The default is 3 seconds. A value equal to '0' will disable this check.	
<b>InitialPause</b>	Initial delay in seconds before first playout; default: no pause.	
<b>SilenceDetection</b>	Enable silence detection during voicemail recording; default: on.	
<b>SilenceSeconds</b>	How many seconds of silence will result in canceling of voicemail recording; default: 2.	
<b>FaxDetection</b>	Enable fax detection during voicemail recording; default: on.	
<b>MailTemplate</b>	Mail message template. Specifies the file that will be used as the body template for voicemail and fax messages. Messages will have no body if MailTemplate is not set. Default: no message body. Example: MailTemplate=/home/porta-um/etc/mail-template.txt	
<b>CleanupPeriodINBOX</b>	Cleanup of user's Inbox folder. All messages older than the selected value (in days) will be moved to the Trash folder. A zero value disables cleanup. Default: 30.	
<b>CleanupPeriodTrash</b>	Cleanup of user's Trash folder. All messages older than the selected value (in days) will be permanently deleted. A zero value disables cleanup. Default: 30.	
<b>DefaultPromptTimeout</b>	Default timeout for all voice prompts, in milliseconds; default: 9000.	
<b>RecordTimeout</b>	Default timeout for recording voicemails and greetings, in milliseconds; default: 200000.	
<b>EnvMap</b>		
<b>Env&lt;N&gt;</b>	Parameter names (the part to the left of the equal sign) must contain sequential numbers, e.g. Env1, followed by Env2, Env3, and so on. These numbers are not the same as i_env in PortaBilling, which is	

	<p>specified inside the parameter's value. Parameter values are colon-separated strings in the following format:</p> <pre>Env&lt;N&gt;=&lt;i_env&gt;:&lt;mail_domain&gt;: &lt;SIP_server_IP&gt;:&lt;DNIS_MailBOX&gt;: &lt;DNIS_MailBoxWithPass&gt;: &lt;DNIS_PlayBalance&gt;: &lt;DNIS_RechargeVoucher&gt;</pre> <p>Example:</p> <pre>Env1=3:um.yourcompany.com:porta- sip:*98:1234567890:*11:*12 Env2=4:um.othercompany.com:porta- sip2:*98:18001234567:*11:*12</pre>
--	--